



CATALOG



PRO AQUA

PIPES AND FITTINGS
FOR WATER SUPPLY & HEATING SYSTEMS





CONTENT

PRO AQUA factory	2
Production laboratory.....	2
Introduction.....	4
Material.....	4
Terms and Definitions.....	4
Basic parameters and dimensions.....	5
Technical requirements.....	8
Reliability requirements.....	8
Safety and environmental requirements.....	9
Transportation and storage.....	10
Installation Instructions.....	10
Appendix A.....	11
Appendix B.....	12
The main characteristics of polypropylene.....	12
Distinctive features of polypropylene.....	13
Reinforced PP-R Pipe.....	13
PP-R Pipeline Design.....	14
Hydraulic calculation.....	15
Hydraulic resistance coefficient.....	17
Linear expansion compensation.....	18
The basic principles of laying pipelines made of polypropylene.....	22
Fastening PP-R pipelines.....	23
Installation of PP-R pipelines.....	23
Welding machine.....	23
Tool preparation.....	24
Welding parts to the socket.....	24
Pipeline Testing.....	27
Water systems.....	27
Heating systems.....	27
Pipe insulation.....	28
Transportation and storage of PP-R pipes.....	29
Safety requirements.....	29
Normative references.....	30
Appendix 1.....	30
Appendix 2.....	36
Flanged connections using polypropylene pipes.....	37
Product range: pipes, fittings, tools.....	41
An example of the location of distribution blocks.....	58



These products were manufactured under the control established in the quality management system certified by Bureau Veritas Certification and complying with the requirements of ISO 9001: 2015, certificate no: RU005604

Nº: RU005604

PRO AQUA Factory



PRO AQUA FACTORY

The PRO AQUA factory is one of the largest manufacturers, producing polypropylene and polyethylene piping systems for over 23 years for internal and external utility networks. The company's production facility is equipped with modern high-precision European equipment (ZWICK; VINDER; SCITEQ). The factory has a certified laboratory which monitors the quality of all products manufactured at the factory. Thanks to constant monitoring, the products produced by the factory maintain consistently high quality. All products manufactured by the company have a warranty period of 10 years.

PRODUCTION LABORATORY

The production laboratory of the enterprise PRO AQUA LLC is a structural subdivision with the functions of conducting technical control at all stages of the production process.

PRO AQUA NPO LLC is equipped with modern measuring instruments and equipment for testing polymer products from leading European manufacturers (ZWICK; BINDER; SCITEQ). The laboratory has been certified by FBU "The State Regional Centre for Standardization, Metrology and Testing in the Moscow Region" for the conditions necessary for performing measurements and tests in the field of activity assigned to the laboratory in accordance with the requirements of GOST R ISO / IEC 17025-2006.

1.1. Introduction

PP-R Pipes and fittings for hot and cold water supply and heating systems have several advantages:

- Resistance to high temperatures;
- Excellent hygienic properties;
- Vibration and noise suppression;
- Absolute corrosion resistance;
- Chemical resistance to more than three hundred substances and solutions;
- Smooth inner pipe surface durable in time;
- Easy installation and repair;
- Thermal insulation properties - 0,22 W/m²K;
- Environmental friendliness (recycling);
- No harmful gas emission if burned. Non-toxic.

1.2. Material

Polypropylene is an isotactic thermoplastic whose macromolecules have a spiral conformation. It was first obtained in 1954. Polypropylene is obtained by the chain growth polymerisation of propylene which is produced by petroleum cracking and has the following chemical formula:



Polypropylene has the following modifications:

- Propylene homopolymer (type 1) PP-H;
- Copolymer of propylene and ethylene (type 2) PP-B – block copolymer;
- Random copolymer propylene with ethylene (type 3) – initially designated as PPRC... - PPRC - polypropylene random copolymer, further this abbreviation was reduced to PP-R.

PRO AQUA pipes and fittings are manufactured using type 3 polypropylene – random PP-R-100 copolymer (MRS 100).

Random copolymer PP-R is obtained by polymerisation of propylene and ethylene molecules in a random combination and is represented by the following graphic formula:

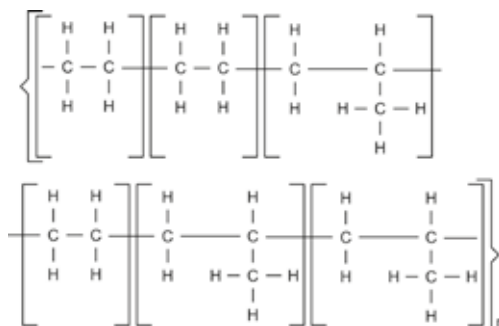

1.3. Terms and definitions

The following terms and definitions are used to characterize polypropylene pipes:

- **Thermoplastic materials (thermoplastics):** A group of polymeric materials that, when heated above the melting point, retain the ability to transition to a viscous state.
- **Average outer diameter OD, mm:** The quotient from dividing the circumference of a pipe, measured by the outer diameter in any cross section, by the number π ($\pi = 3.142$), rounded up to 0.1 mm.
- **Nominal outer diameter DN, mm:** Nominal size adopted for the classification of thermoplastic pipes and all components of the piping systems, corresponding to the d_{em} minimum allowable value of the average outer diameter of the pipe.
- **Nominal wall thickness e, mm:** Nominal size corresponding to the minimum allowable wall thickness of the pipe at any point of its cross section.
- **Minimum required MRS, MPa:** Characteristics of the pipe material, numerically equal to the stress in the wall, arising under the action of constant internal pressure, which the pipe is able to withstand at a lower confidence interval of 97.5% for 50 years at a temperature of 20 °C, rounded according to GOST 8032 to the nearest lower value of the R 10 series, if the stress value is not more than 10 MPa, or the R 20 series, if this value is more than 10 MPa.
- **Design stress σ_s , MPa:** Allowable stress in the pipe wall for 50 years at a temperature of 20 °C, taking into account the safety factor C, determined by the following formula, followed by rounding according to GOST 8032 to the nearest lower value of the R 10 series, if this value is no more 10 MPa, or R 20 series, if it is more than 10 MPa.

$$\sigma_s = MRS/C, (1),$$

where **MRS** is the minimum long-term strength, MPa;
R – factor of safety in accordance with table 12.

safety factor C: A dimensionless parameter that has a larger value than one, taking into account the features of the pipeline operation, as well as its properties that differ from those taken into account when calculating MRS.

pipe series S (nominal): A dimensionless parameter defined as the ratio of the design stress σ_s to the maximum allowable operating pressure PPMS.

SDR Standard Dimension Ratio: : A dimensionless parameter that is numerically equal to the ratio of the nominal outer diameter of the pipe d to the nominal wall thickness e . The values of SDR and S are related as follows:

$$SDR = 2S+1, (2)$$

where S - serie of pipes.

maximum permissible operating pressure MAWP, MPa: The maximum value of the constant internal pressure of water in a pipe at a temperature of 20 °C for 50 years, rounded according to GOST 8032 to the nearest lower value of the R 10 series , if this value is not more than 10 MPa, or the R 20 series if it is more than 10 MPa. It is related to a series of pipes S by the following equation:

$$MAWP = \sigma_s / S, (3)$$

where σ_s is the design stress;
 S is a series of pipes.

nominal pressure PN, bar: The nominal value used to classify pipes from thermoplastics, numerically equal to the maximum allowable operating pressure, expressed in bar (1 bar = 0.1 MPa). Maximum operating pressure at constant temperature MOP, MPa: The maximum value of the constant internal pressure of water in the pipeline during the service life of 50 years, determined by the following formula:

$$MOP = 2MRSc_t / (C(SDR-1)), (4)$$

where MRS is the minimum required strength, MPa;
 C is the safety factor;
 SDR is the standard dimensional ratio;

C_t is the coefficient of reducing the maximum operating pressure at a water temperature of more than 20 °C;

Maximum operating pressure at variable temperature conditions P_{max} , MPa: the maximum water pressure in the pipe under specified operating conditions, determined by the following formula:

$$P_{max} = \sigma_0 / S,$$

where σ_0 is the design stress in the pipe wall, MPa, for a given class of operation, determined according to Miner's rule;
 S is a series of pipes.

pipe opacity N, %: The ratio of the luminous flux transmitted through the sample to the luminous flux of the source, expressed as a percentage.

1.4. Basic parameters and dimensions

1.4.1 The nominal outer diameter of pipes d and the nominal wall thickness of pipe e , depending on the nominal S series and standard dimensional ratios SDR are listed in Table 1.

The nominal pipe wall thicknesses indicated in the Table were determined according to the calculated series. It is allowed to establish other nominal diameters and pipe series in accordance with regulatory documents for products.

1.4.2 Limit deviations of the average outer diameter and the permissible ovality of the pipes are listed in Table 2, while the maximum deviations of the wall thickness are specified in Table 3.

1.4.3 Pipes from PP-R are produced as straight sections.

1.4.4. The calculated mass of PP-R pipes of the most applicable series is given in Appendix A.

Table 1.

Nominal Outer diameter d	Standart Dimension Ratio SDR			
	5	6	7,4	11
	Nominal wall-thickness of PP Pipe			
	PP-R	PP-R	PP-R	PP-R
16	3,3	2,7	2,2	1,8
20	4,1	3,4	2,8	1,9
25	5,1	4,2	3,5	2,3
32	6,5	5,4	4,4	2,9
40	8,1	6,7	5,5	3,7
50	10,1	8,3	6,9	4,6
63	12,7	10,5	8,6	5,8
75	15,1	12,5	10,3	6,8
90	18,1	15	12,3	8,2
110	22,1	18,3	15,1	10
125	25,1	20,8	17,1	11,4



Table 2. Limit deviations of the average external diameter and permissible ovality of pipes

Nominal outer diameter d	Pipe material	
	PP-R	
	Deviation limit (+) ¹	Ovality ²
16	0,3	1,2
20	0,3	1,2
25	0,3	1,2
32	0,3	1,3
40	0,4	1,4
50	0,5	1,4
63	0,6	1,6
75	0,7	1,6
90	0,9	1,8
110	1	2,2
125	1,2	2,5

1 - Maximum deviation of the external average diameter corresponds to group A.

2 - Ovality corresponds to group N.

Notes:

1. Limit deviations of the average outer diameters are calculated according to the following formulas:

- Group A: (+ 0.009d), rounded to 0.1 mm;
- Group B: (+ 0.006d), rounded to 0.1 mm;
- Group C: (+ 0.003d), rounded to 0.1 mm.

2. The permissible ovality of the pipes is calculated by the following formulas:

Group N: (0.008d + 1), rounded to 0.1 mm in pipes lengths measured immediately after production; group M: (0,024d), rounded to 0.1 mm in pipes lengths measured immediately after production.

Table 3. Limit deviations of pipe wall thickness

Nominal wall thickness e	Deviation limit wall thickness (+) ¹	
	<	PP-R
>	<	PP-R
1	2	0,4
2,1	3	0,5
3,1	4	0,6
4,1	5	0,7
5,1	6	0,8
6,1	7	0,9
7,1	8	1
8,1	9	1,1
9,1	10	1,2
10,1	11	1,3
11,1	12	1,4
12,1	13	1,5
13,1	14	1,6
14,1	15	1,7
15,1	16	1,8
16,1	17	1,9
17,1	18	2
18,1	19	2,1
19,1	20	2,2
20,1	21	2,3
21,1	22	2,4
22,1	23	2,5
23,1	24	2,6
24,1	25	2,7
25,1	26	2,8

1 - Maximum deviations of wall thickness correspond to the group W.

Notes 1. Limit wall thickness deviations are calculated according to the following formula:

- Group W: (0.1 e + 0.2), rounded to 0.1.

2. For specific types of pipes, the limit wall thickness deviations for walls corresponding to groups T, U, V, calculated by the following formulas are allowed to establish in ND (regulatory documentation):

- group T: (0.1 e + 0.2) for the wall thickness from 1.0 to 4.6 mm inclusive and (+ 0.15e) - from 4.6 to 50.0 mm, rounded to 0.1 mm;
- group U: (+ 0.2 e), rounded to 0.1 mm;
- Group V: (0.1 e + 0.1), rounded to 0.1 mm.

1.5. Technical requirements

1.5.1 Specifications

1.5.1.1

Pipes shall have a smooth outer and inner surface. Insignificant longitudinal strips and waviness may be present on the pipes provided that they do not take the pipe wall thickness out of tolerance limits. Bubbles, cracks, shells, foreign inclusions are not allowed on the outer, inner and end surfaces. Pipes shall be painted continuously and uniformly. The color of the pipes shall be specified in the regulatory documents for products.

The appearance of the pipes shall comply with the control sample, approved under the established procedure.

Table 4 Operating conditions according to EN ISO 15874

Operation class	T _D , °C	Time at T _D years	T _{Max} , °C	Time at T _{max} , years	T _{emerg} , °C	Time at T _{emerg} , hours	Field of Application
1	60	49	80	1	95	100	Hot water supply (60 °C)
2	70	49	80	1	95	100	Hot water supply (70 °C)
3	30 40	20 25	50	4,5	65	100	Low temperature floor
4	20 40 60	2,5 20 25	70	2,5	100	100	Heating High temperature floor heating Low temperature heating by heating appliances
5	20 60 80	14 25 10	90	1	100	100	High temperature heating by heating appliances

The following designations are used in Table 5: Top is the operating temperature or combination of temperatures corresponding to transported water which is defined by the application field.

T_{max} is the maximum operating temperature, with its time-limited exposure.

T_{emerg} is the emergency temperature arising under emergencies due to upset of control systems.

1.5.2 Reliability requirements

1.5.2.1 Pipes and fittings of thermoplastics shall be used in water supply and heating systems under temperature conditions specified in Table 4.

1.5.2.2 The maximum service life of the pipeline for each class of operation is determined by the total operating time of the pipeline at temperatures Top, Tmax, Temerg and is 50 years.

1.5.2.3. If the service life is less than 50 years, all time characteristics, except Temerg, shall be proportionally reduced.

1.5.2.4 Other classes of operation may be established, but temperatures shall not exceed the values specified for class 5.

Determination of the calculated series of pipes

1.5.2.5 Calculated series for pipes of operating classes 1-5 S'max, which determine the minimum permissible wall thickness, are calculated by the formula (formula 9).

$$S'max = \sigma_0 / Pmax, (9)$$

where σ_0 is the calculated stress in the pipe wall, MPa, for operating classes 1, 2, 3, 4, 5, determined according to the Miner rule;

P_{max} - maximum operating pressure 0,4; 0,6; 0,8; 1,0 MPa.

Note – the wall thickness of the pipe with a protective layer is calculated as the sum of the minimum allowable wall thickness, determined by the formula (9), and the thickness of the protective layer.

1.5.2.6 When determining the S'_{max} , rounding is performed down to the nearest value of the S series, shown in Table 1.

1.5.2.7 The minimum value of the safety factor of PP-R pipes at a temperature of 20 °C for 50 years is established by GOST ISO 12162.

1.5.2.8 Wall thicknesses of thermoplastic fittings shall be not less than those for pipes of the same size and the same operating conditions.

1.5.3 Requirements for raw materials, materials and components:

1.5.3.1 The required strength of the material of pipes and fittings under the action of a constant internal pressure shall not be less than that specified by the reference curves and equations presented in Appendix B. Material tests for compliance with the specified requirements shall be carried out on samples of pipes manufactured by extrusion or injection molding at least at two temperatures and five pressure levels for each temperature. The total number of tested samples at each temperature shall be at least 30. When tested, at least four failures of pipe samples shall be recorded not earlier than in 7000 hours and at least one failure shall be recorded not earlier than in 9000 hours.

The value of the minimum required strength MRS, MPa, shall be determined by extrapolating the test results at a temperature of 20 °C for a service life of 50 years.

1.5.3.2 For production of pipes and fittings the following materials and recipes shall be applied as specified in the regulatory documents for products:

1.5.3.2.1 Polypropylene homopolymer PP-H 100 having the minimum required strength MRS of not less than 10.0 MPa; polypropylene random copolymer PP-R 80 having MRS of not less than 8.0 MPa with a melt flow rate determined according to GOST 11645 at (230 °C / 2.16 kg), not more than 0.5 g / 10 min, and at (190 °C / 5.0 kg) – not more than 1.0 g / 10 min.

1.5.3.2.3 Types and brands of metals and coatings used for production of fittings and embedded elements of combined parts shall not cause destruction of the polymer material and shall be specified in the regulatory documents for products.

1.5.3.2.4 Elastic sealing rings shall be made of rubber or other elastomers in accordance with regulatory documents and ensure the strength and tightness of the joints during the entire specified service life of the pipeline.

1.5.3.2.5 Adhesives shall comply with the requirements of regulatory documents and shall not affect the properties of the parts to be joined.

1.5.3.2.6 All materials used for production of pipelines transporting drinking water shall be authorized for the specified use by health authorities.

1.6 Safety and environmental requirements

1.6.1 Fire protection is regulated in accordance with national regulations in each country. Building authorities and fire protection consultants will provide information on this issue. ProAqua pipes and fittings fulfill the requirements of fire class B 2, i.e. they are classified as normally inflammable. Where the pipe system is penetrated through structural parts of the building, appropriate measures shall be taken to maintain the required fire resistance capabilities during the installation. Fire-safety characteristics of pipes and fittings made of thermoplastics are listed in Table 5. Note – The values of fire-technical characteristics for specific recipes of raw materials may be specified in the regulatory documents for products.

1.6.2 The extent and type of the protective measures required depends on the type of installation. In particular, fire walls and ceilings shall be restored to their original fire resistance class after installation of pipes penetrating therethrough.



1.7 Transportation and storage

1.7.1 Pipes and fittings could be transported by any type of vehicles in accordance with the rules for the carriage of goods and the technical conditions for loading and securing goods operating on this type of transporter. Transportation shall be carried out with the maximum use of the capacity of the vehicle.

1.7.2 Pipes shall be protected from shocks and mechanical loads and their surface from scratching. When transporting, the pipe shall be laid on a flat surface of vehicles, protecting it from sharp metal corners and edges of the platform.

1.7.3 Pipes and fittings shall be stored in unheated warehouses in conditions that exclude the likelihood of their mechanical damage, or in heated warehouses no closer than one meter from heating appliances. They shall be protected from direct sunlight and precipitation.

Pipes should be stored at temperature between -50 °C and +50 °C protected from direct sunlight. The pipes should not be moved when temperature below -20 °C. If temperature is between -20 °C and -10°C pipes should be moved with extra precaution.

Pipes can be stored without UV protection not longer than 6 months

1.8 Installation Instructions

1.8.1 Installation of pipelines for systems of cold and hot water supply and heating shall be carried out in accordance with the requirements of the applicable regulatory documents: SP 30.13330.2016 "Internal water supply and sewerage of buildings. Updated version of SNiP 2.04.01-85, SP 73.13330.2016" Internal sanitary systems of buildings. Updated version of SNiP 3.05.01-85", SP 60.13330.2016 "Heating, ventilation and air conditioning. Updated version of SNiP 41-01-2003", SP 40-101-96 and other documents approved in the prescribed manner.



APPENDIX A

Design mass of 1 meter of PP-R monolayer pipes are given in Table A. 1

Table A. 1

Nominal Outer Diameter d	Design mass of 1 meter pipe (kg)	
	SDR 11	SDR6
20	0,107	0,172
25	0,164	0,266
32	0,261	0,434
40	0,412	0,671
50	0,638	1,04
63	1,01	1,65
75	1,41	2,34
90	2,03	3,36
110	3,01	5,01
125	3,91	6,47



APPENDIX B

Table B.1 The main characteristics of polypropylene

Molecular weight (atomic weight unit)	75 000 – 300 000
Density, g / cm ³	0,91 – 0,92
Tensile stress at yield, N / mm ²	27 – 30
Rupture strength, N/mm ²	34 – 35
Relative elongation at rupture, %	> 500
Elasticity coefficient, MPa	900 – 1200
Heat resistance, °C	100
Melting point, °C	> 146
Mean linear expansion factor, mm/m · °C	0,15
Heat conduction coefficient, W/(m · °C)	0,23

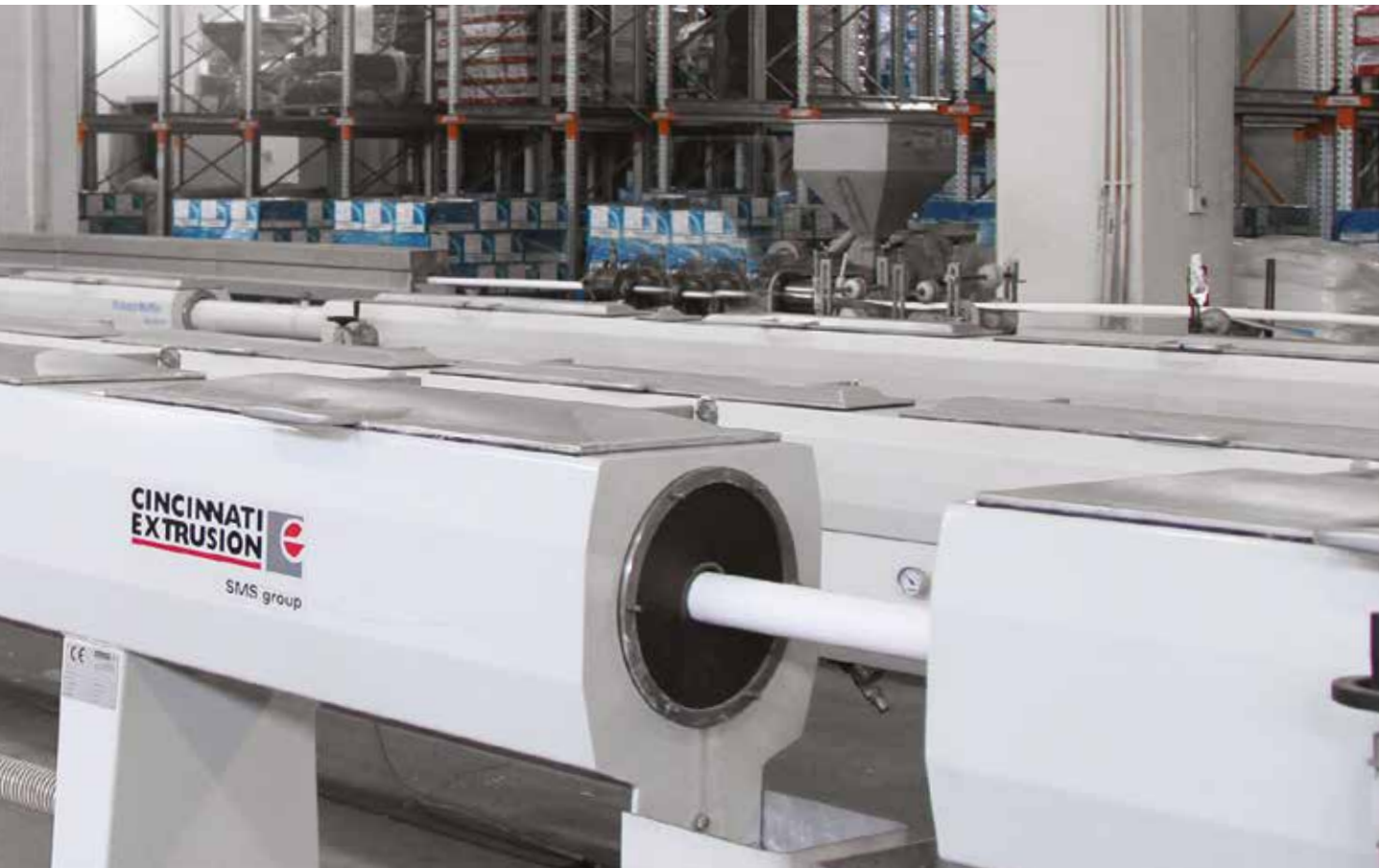

1.9. Distinctive features of polypropylene

Polypropylene is characterized by high resistance to repeated bending and abrasion. Polypropylene versus polyethylene, has a higher resistance to surface-active substances (surfactants). Notched impact strength is 5-12 kJ/m², it is frost-resistant at negative temperatures. Polypropylene is the most commonly used in the systems of cold and hot water supply as well as for internal and external sewage systems.

1.10. Reinforced PP-R pipes

Reinforced polypropylene pipes are produced on the stage-by-stage basis.

Initially, a uniform polypropylene pipe is produced by extrusion.

Then, in a continuous process, the solid outer surface of the pipe is tightly covered with perforated or non-perforated aluminum strip. Next, the resulting pipe structure is again extruded (a new layer of polypropylene is applied on top of the aluminum shell).

One of the main objectives of pipe reinforcement is to drastically reduce temperature elongations of thermoplastic pipe which are rather significant for non-reinforced polypropylene pipes.

It is no coincidence that the developers of reinforced polypropylene pipes, having achieved the industrial realization of such a reinforced structure, call it "stable" one. The term 'stable' refers to a small change in the original length of the pipe when it is heated or cooled.

The thermal coefficient of linear expansion α (mm / m · °C) for aluminum-reinforced PP-R pipe is $\alpha = 0.03$, and for glass-fiber reinforced $\alpha = 0.15$.

Wall thickness of inner PP-R layer of aluminium foiled pipes is equal to that of monolayer pipes of the corresponding class. Aluminium layer (b-1) and outer PP-R layer (b-3) increases wall thickness and outer diameter of the pipe. Therefore, before welding, it is necessary to remove outer PP-R layer (b-3) and aluminium layer (b-2) using a special shaver which is offered by ProAqua. Following the shaving process, the pipe is welded as monolayer pipes. DUO pipe is reinforced with aluminum in the centre and has a wall thickness in accordance with SDR6. However, this does not mean that such a pipe does not require special treatment. The interaction of aluminum with neutral water is often not dangerous, since the metal is protected by an oxide film. For example, aluminum is subject to intense corrosion. This leads to the separation of pipes and a significant decrease in its strength properties. As a layer of aluminum foil is in contact with a transported medium, a special tool is used - a flat-cutter, which cuts the groove through the wall thickness at the aluminum layer to a depth of 1-2 mm. This is enough to weld the aluminum layer reliably so to cover it with the fused polypropylene.

For glass fiber reinforced pipes, the technology does not imply stripping

Two types of PRO AQUA reinforced pipes are manufactured: perforated and smooth ones. The difference between the perforated shell of the PP-R-reinforced pipe and the smooth one is that the aluminum shell has frequent perforations in the form of the grid with small-diameter holes.

During extrusion of a polypropylene pipe, the viscous-flow material flows into these holes and thereby creates a bond between a polymer and a metal. "Shrinkage cavities" noticeable by eye, repeating the applied perforation structure remain on the surface of pipes of such type.

The reinforcement of PP-R pipes provides for its temperature stabilizing capacity and makes it possible to create one more important function i.e. arrangement of the anti-diffusion barrier that prevents the penetration of oxygen molecules through the pipe wall into the heat carrier medium.

1.11. Design of PP-R Piping Systems

PP-R piping for cold and hot water systems is designed in accordance with the regulations SP 30.13330.2016 "Internal water supply and sewerage of buildings. Updated version of SNiP 2.04.01-85. and the "Set of rules for the design and installation of polypropylene random copolymer pipelines" SP 40-101-96.

Reinforcement diagram and design construction of PP-R pipe

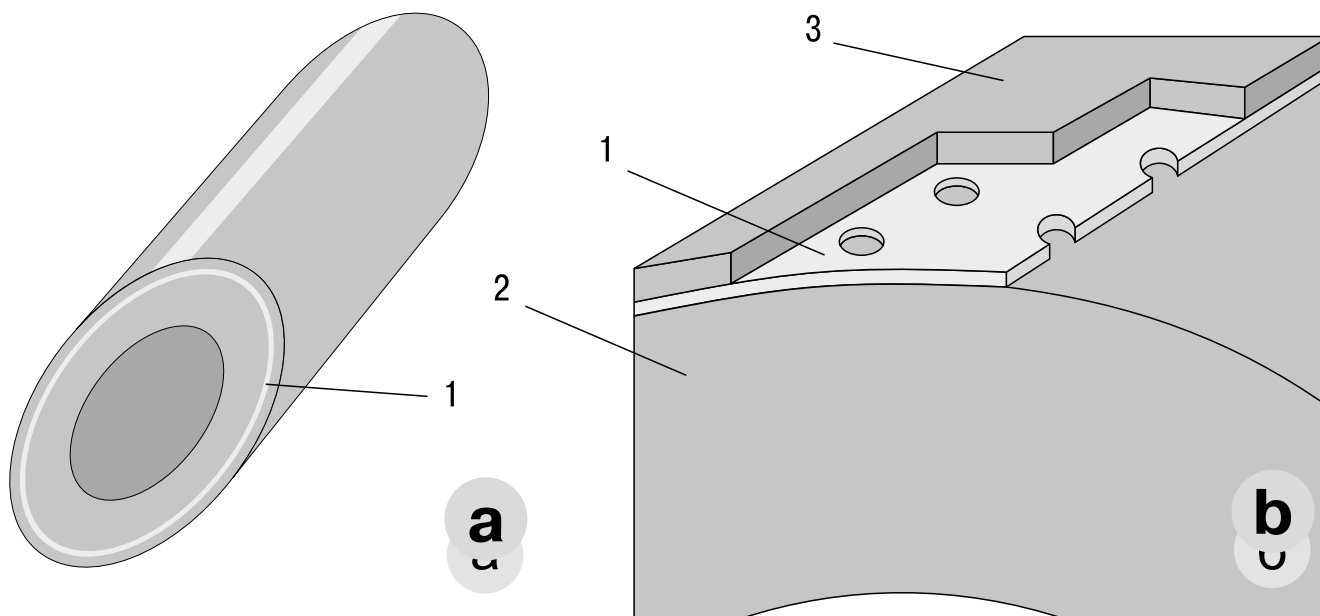

a – is the section of reinforced PP-R pipe;
1 – a layer of aluminium or fiberglass

b – PP-R reinforced pipe design;
1 – a layer of aluminium (perforated or non-perforated) or fiberglass;
2, 3 – polypropylene layer.

1.11.1. Hydraulic calculation

Hydraulic calculation of PP-R pipelines consists in determining the head (or pressure) losses to overcome the hydraulic resistances occurring in the pipe, in the connecting parts, in places of sharp turns and changes in the diameter of the pipeline.

Hydraulic head loss in the pipeline is determined by nomograms 6.1 and 6.2.

Nomogram 6.1 to determine the head loss in SDR11 pipes

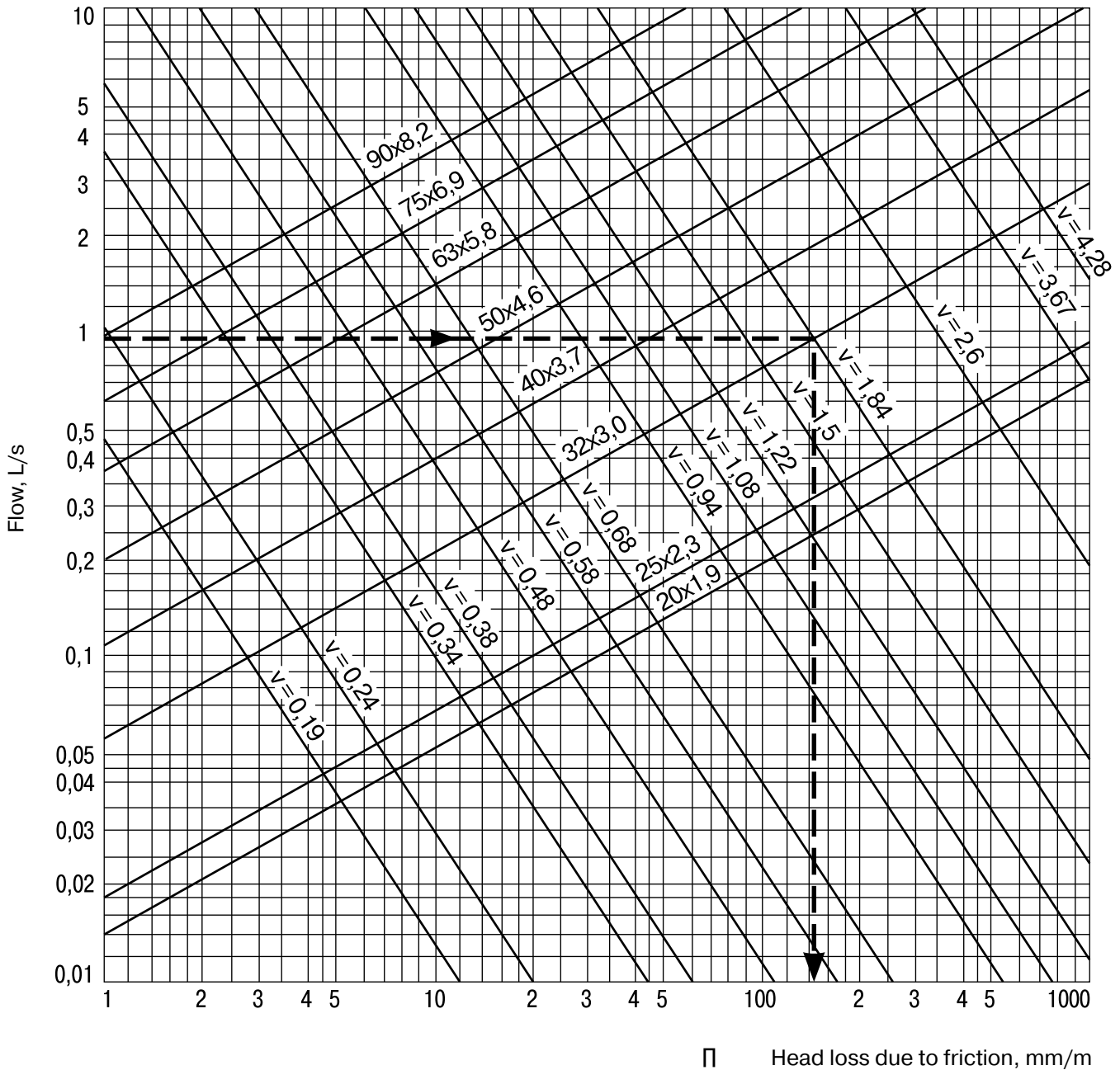



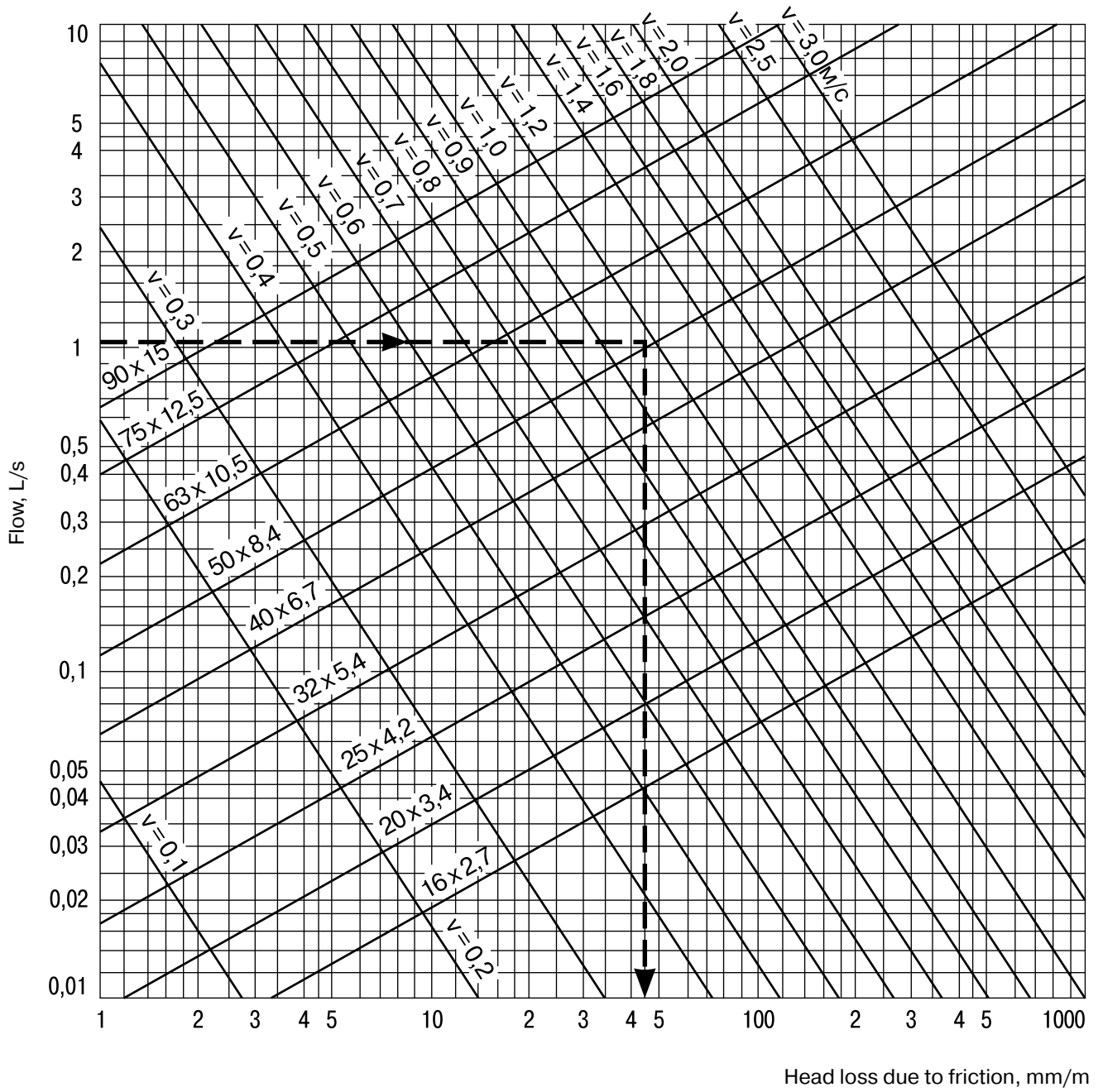









Nomogram 6.2
to determine the head loss in SDR6 & SDR5 pipes



1.11.2. Hydraulic resistance coefficient

Hydraulic pressure loss due to local resistance in the connecting parts is recommended to determine according to the following Table:

Table 9. Local hydraulic resistance coefficient for polypropylene fittings

Type	Designation	Remarks	Coefficient
Socket			0,25
Reducing Socket		Reduction by 1 size	0,40
		Reduction by 2 size	0,50
		Reduction by 3 size	0,60
		Reduction by 4 size	0,70
Elbow 90°			1,20
Elbow 45°			0,50
T-Part		Flow Separation	1,20
		Flow Connection	0,80
Four-way union		Flow Connection	2,10
		Flow Separation	3,70
Combined socket female			0,50
Combined socket Male			0,70
Combined Elbow Female			1,40
Combined Elbow Male			1,60
Combined T Pipe Female			1,40 – 1,80
Valve		20 mm	9,50
		25 mm	8,50
		32 mm	7,60
		40 mm	5,70

1.11.3. Linear expansion compensation

Since polymeric materials have higher coefficient of linear elongation compared with metals, when designing heating systems, cold and hot water supply, it is needed to calculate linear changes in pipelines that occur during temperature changes.

Design and installation of pipelines shall be performed so that the pipe can move freely within the design linear expansion range. This is achieved due to the compensating ability of the pipeline elements, the installation of temperature expansion joints and the correct placement of supports (fixings). Stationary pipe fixings shall direct pipe elongations towards these elements.

The change in the length of the pipeline when its temperature changes is calculated according to the formula:

$$\Delta L = \alpha \cdot L \cdot \Delta t, \text{ where}$$

ΔL - change in the length of the pipeline when it is heated or cooled, mm;

α - thermal expansion coefficient: mm / m · °C;

L - is the estimated length of the pipeline, m;

Δt - is the temperature difference of the pipeline during installation and operation °C (K)

Table 10. Table of linear expansion (in mm): monolayer pipe (no reinforcement) ($\alpha = 0.15 \text{ mm} / \text{m} \cdot \text{°C}$)

Length pipe, m	Temperature difference Δt , °C							
	10	20	30	40	50	60	70	80
0,1	0,15	0,30	0,45	0,60	0,75	0,90	1,05	1,20
0,2	0,30	0,60	0,90	1,20	1,50	1,80	2,10	2,40
0,3	0,45	0,90	1,35	1,80	2,25	2,70	3,15	3,60
0,4	0,60	1,20	1,80	2,40	3,00	3,60	4,20	4,80
0,5	0,75	1,50	2,25	3,00	3,75	4,50	5,25	6,00
0,6	0,90	1,80	2,70	3,60	4,50	5,40	6,30	7,20
0,7	1,05	2,10	3,15	4,20	5,25	6,30	7,35	8,40
0,8	1,20	2,40	3,60	4,80	6,00	7,20	8,40	9,60
0,9	1,35	2,70	4,05	5,40	6,75	8,10	9,45	10,80
1,0	1,50	3,00	4,50	6,00	7,50	9,00	10,50	12,00
2,0	3,00	6,00	9,00	12,00	15,00	18,00	21,00	24,00
3,0	4,50	9,00	13,50	18,00	22,50	27,00	31,50	36,00
4,0	6,00	12,00	18,00	24,00	30,00	36,00	42,00	48,00
5,0	7,50	15,00	22,50	30,00	37,50	45,00	52,50	60,00
6,0	9,00	18,00	27,00	36,00	45,00	54,00	63,00	72,00
7,0	10,50	21,00	31,50	42,00	52,50	63,00	73,50	84,00
8,0	12,00	24,00	36,00	48,00	60,00	72,00	84,00	96,00
9,0	13,50	27,00	40,50	54,00	67,50	81,00	94,50	108,00
10,0	15,00	30,00	45,00	60,00	75,00	90,00	105,00	120,00

**Table 11. Linear expansion table (in mm): PP-R aluminium foiled pipe
($\alpha = 0.03 \text{ mm} / \text{m} \cdot ^\circ\text{C}$)**

Length pipe, m	Temperature difference Δt , $^\circ\text{C}$							
	10	20	30	40	50	60	70	80
0,1	0,03	0,06	0,09	0,12	0,15	0,18	0,21	0,24
0,2	0,06	0,12	0,18	0,24	0,30	0,36	0,42	0,48
0,3	0,09	0,18	0,27	0,36	0,45	0,54	0,63	0,72
0,4	0,12	0,24	0,36	0,48	0,60	0,72	0,84	0,96
0,5	0,15	0,30	0,45	0,60	0,75	0,90	1,05	1,20
0,6	0,18	0,36	0,54	0,72	0,90	1,08	1,28	1,44
0,7	0,21	0,42	0,63	0,84	1,05	1,26	1,47	1,68
0,8	0,24	0,48	0,72	0,96	1,20	1,44	1,68	1,92
0,9	0,27	0,54	0,81	1,08	1,35	1,62	1,89	2,16
1,0	0,30	0,60	0,90	1,20	1,50	1,80	2,10	2,40
2,0	0,60	1,20	1,80	2,40	3,00	3,60	4,20	4,80
3,0	0,90	1,80	2,70	3,60	4,50	5,40	6,30	7,20
4,0	1,20	2,40	3,60	4,80	6,00	7,20	8,40	9,60
5,0	1,50	3,00	4,50	6,00	7,50	9,00	10,50	12,00
6,0	1,80	3,60	5,40	7,20	9,00	10,80	12,80	14,40
7,0	2,10	4,20	6,30	8,40	10,50	12,60	14,70	16,80
8,0	2,40	4,80	7,20	9,60	12,00	14,40	16,80	19,20
9,0	2,70	5,40	8,10	10,80	13,50	16,20	18,90	21,60
10,0	3,00	6,00	9,00	12,00	15,00	18,00	21,00	24,00

**Table 12. Linear expansion table (in mm): glass fiber reinforced PP-R pipe
($\alpha = 0.035 \text{ mm} / \text{m} \cdot ^\circ\text{C}$)**

Length pipe, m	Temperature difference Δt , ($^\circ\text{C}$)									
	10	20	30	40	50	60	70	80	90	100
0,1	0,03	0,07	0,10	0,14	0,17	0,21	0,24	0,28	0,31	0,35
0,2	0,07	0,14	0,21	0,28	0,35	0,42	0,49	0,56	0,63	0,70
0,3	0,10	0,21	0,31	0,42	0,52	0,63	0,73	0,84	0,94	1,05
0,4	0,14	0,28	0,42	0,56	0,70	0,84	0,98	1,12	1,26	1,40
0,5	0,17	0,35	0,52	0,70	0,87	1,05	1,22	1,40	1,57	1,75
0,6	0,21	0,42	0,63	0,84	1,05	1,26	1,47	1,68	1,89	2,10
0,7	0,24	0,49	0,73	0,98	1,22	1,47	1,71	1,96	2,20	2,45
0,8	0,28	0,56	0,84	1,12	1,40	1,68	1,96	2,24	2,52	2,80
0,9	0,31	0,63	0,94	1,26	1,57	1,89	2,20	2,52	2,83	3,15
1,0	0,35	0,70	1,05	1,40	1,75	2,10	2,45	2,80	3,15	3,50
2,0	0,70	1,40	2,10	2,80	3,50	4,20	4,90	5,60	6,30	7,00
3,0	1,05	2,10	3,15	4,20	5,25	6,30	7,35	8,40	9,45	10,50
4,0	1,40	2,80	4,20	5,60	7,00	8,40	9,80	11,20	12,60	14,00
5,0	1,75	3,50	5,25	7,00	8,75	10,50	12,25	14,00	15,75	17,50
6,0	2,10	4,20	6,30	8,40	10,50	12,60	14,70	16,80	18,90	21,00
7,0	2,45	4,90	7,35	9,80	12,25	14,70	17,15	19,60	22,05	24,50
8,0	2,80	5,60	8,40	11,20	14,00	16,80	19,60	22,40	25,20	28,00
9,0	3,15	6,30	9,45	12,60	15,75	18,90	22,05	25,20	28,35	31,50
10,0	3,50	7,00	10,50	14,00	17,50	21,00	24,50	28,00	31,50	35,00

L-Shaped expansion joint

Figure 6.1. The design diagram of the L-shaped expansion joint::

HO – fixed support;
 CO – sliding support;
 L spr. sect. – the length of the spring section from the pipe axis to the edge of the fixed support, mm
 ΔL – increase the length of the horizontal section pipeline during heating, mm
 L Co – the distance between the edges of fixed supports, mm;
 the distance between the edge of the fixed and the centre of the sliding support, and also between the centres.

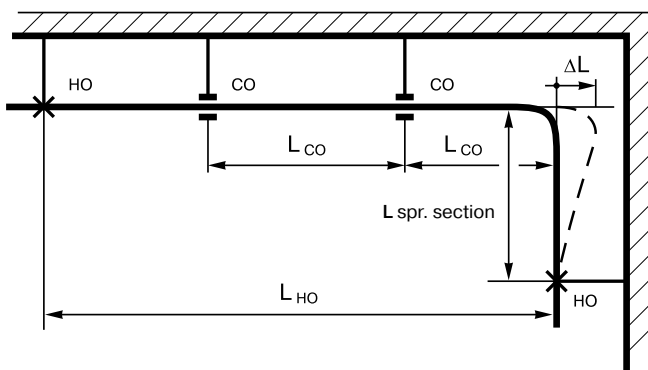

U-Shaped expansion joint

Figure 6.2. Calculation diagram of U- and U-shaped expansion joints:

HO – fixed support;
 CO – sliding support;
 L spr. sect. – the length of the spring section from the pipe axis to the edge of the fixed support, mm
 b – expansion joint width (insert), distance between the axes of the gauge, mm;

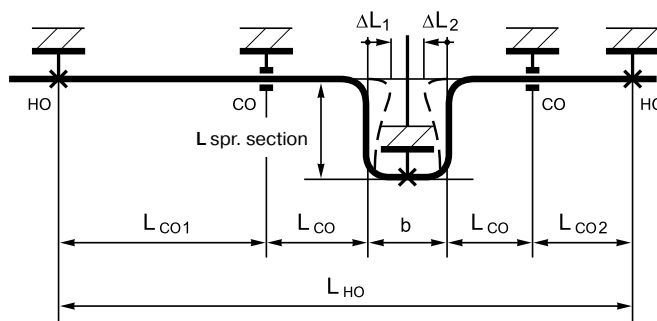

The compensation of thermal extensions is solved constructively, using angles of rotation, sliding and fixed supports, as well as ready-made expansion joints. In fixed supports, the pipe is rigidly fastened with a collar with rubber gasket, and in sliding supports, retainers allow the pipe to move in the axial direction.

Using the example of a pipeline solution in the form of a rotation angle, we calculate the thermal compensation of a horizontal section of a polypropylene pipeline, determining the desired length of the vertical section, which, taking into account the elastic properties of the pipe, will “spring” without failure in the range of the elongation value ΔL .

Figure 6.1. The design diagram of the L-shaped expansion joint:

HO - fixed support;

CO - sliding support;

L spr. sect. - the length of the spring section from the pipe axis to the edge of the fixed support, mm; ΔL - increase in the length of the horizontal section of the pipeline during heating, mm; L but - the distance between the edges of fixed supports, mm;

L co is the distance between the fixed support edge and the sliding support centre as well as that between the centres of sliding supports, mm.

In order to eliminate discrepancies, it is proposed to measure the spring length from the axis of the horizontal section to the fixed support edge in the vertical section. The formula for the pipeline spring section length is as follows:

L spr. sect. = $25 \cdot \sqrt{D} \cdot \Delta L$, where:

L spr. sect. is the spring section length, mm;

D is the outer pipe diameter, mm;

ΔL - pipeline section length increase when heated, mm.

Calculation for the L-shaped expansion joint is performed in the following sequence: Firstly, the thermal elongation value for the calculated section is determined, then the required length of the spring section perpendicular thereto is calculated.

$\Delta L_1, \Delta L_2$ are increase in the length of the horizontal sections of pipelines during their heating, mm; L CO is the distance between the edges of fixed supports, mm;

L CO is the distance between the centre of the sliding support and the pipe bend axis, mm;

L RO1, L RO2 are distances between the fixed support edge and the sliding support edge, mm.

When the pipeline section thermal compensation is provided by the U-shaped pipe expansion joint, 2 ways of its location between the fixed supports may be used:

- the middle (exactly in the middle) placement between the supports where lengths of both equidistributed piping branches located to both sides thereto are equal, i.e. an equal-arm expansion joint design is used;
- displaced placement arising from design solutions when the lengths of pipeline branches are different due to the design features of the facility and the pipeline routing, i.e. the non-equal-arm expansion joint design is used.

In the first case of calculation, the value of DL is equal for both branches of the pipeline and the total elongation is equal to:

$\Delta L_{total} = 2\Delta L.$

In the second case, the DL value is calculated independently for each branch and the elongation is the sum of the calculated elongations: $\Delta L_{total} = \Delta L_{left} + \Delta L_{right}$, where:

$\Delta L_{left} = L_{CO1} + L_{CO};$

$\Delta L_{right} = L_{CO2} + L_{CO}$

The width of the expansion joint b (insert), regardless of the length of its branches, is assigned based on the design and is equal to 11 - 13 D out. The insert is always attached in the middle using a clamp (rigid fixing). Thermal elongation ΔL of the total calculated pipeline sections plus some guaranteed clearance between the expansion joint upper parts approaching to each other (about 150 mm) shall not exceed the width of the expansion joint. Otherwise, it is necessary to reduce the distance between the fixed supports of the calculated sections.

Calculation for the U-shaped expansion joint is carried out in a similar way as for the L-shaped one.

Structural dimensions of U-shaped and L-shaped pipe expansion joints are usually adopted based on calculation.

On the contrary, O-shaped expansion joints for various diameters of plastic pipes are fabricated with calculated fixed values of their geometric dimensions.

O-shaped expansion joint

Fig. 6.3. O- shaped loop expansion joint diagram:

HO is the fixed support; CO is the sliding support; D_{out} is the pipe outer diameter, mm; b is the distance between the expansion joint walls by the internal diameter, mm; L_{HO} is the distance between the edges of fixed supports, mm.

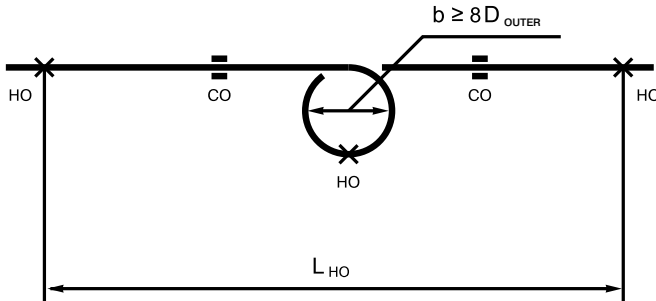

Dimensions expansion joint D, mm	Compensating ability DI, mm
20	80
25	65-70
32	55
40	45

The compensating ability of the O-shaped expansion joint.

1.11.4. The basic principles of laying polypropylene pipelines

Pipelines shall be laid in places where their protection against mechanical damage (pits, grooves, channels, etc.), and their thermal elongation is ensured. If hidden laying of pipelines cannot be arranged, appropriate protection from mechanical damage and fire shall be provided for.

Connecting pipes to plumbing fixings may be laid openly.

The distance between pipes and building structures shall be no less than 20 mm.

In penetrations through building structures of walls and partitions, polypropylene pipes shall be laid in metal cases or sleeves.

The inner diameter of the sleeve shall be 20 to 30 mm larger than the outer diameter of the pipeline passing through it. This gap shall be filled with a soft non-flammable material, which facilitates the free movement of the pipeline along the axis. The sleeve edge shall protrude 30–50 mm beyond the building structure.

It is forbidden to arrange butt joints of both detachable and non-detachable type in the sleeve.

In case where pipelines are laid in a layer of concrete or cement-sand mortar, it is prohibited to embed the detachable threaded connections in concrete.

1.11.5. Fixing of PP-R pipelines

When designing, pipelines are divided into separate sections by distributing the points of rigid fixing. Thus, uncontrolled movement of pipelines is prevented and their reliable fixing is guaranteed. The rigid fixing points are calculated and arranged taking into account the action of forces arising from the expansion of pipelines, as well as additional loads.

Sliding or guide fasteners shall allow movement of the pipe in the axial direction, excluding mechanical damage to the pipe.

The distance between the sliding supports for horizontal laying of the pipeline is determined according to GOST.

Table 13. Distance between supports as a function of water temperature in the pipeline:

Nominal Outside Pipe diameter, mm	Distance, mm						
	20 °C	30 °C	40 °C	50 °C	60 °C	70 °C	80 °C
16	500	500	500	500	500	500	500
20	600	600	600	600	550	500	500
25	750	750	700	700	650	600	550
32	900	900	800	800	750	700	650
40	1050	1000	900	900	850	800	750
50	1200	1200	1100	1100	1000	950	900
63	1400	1400	1300	1300	1150	1150	1000
75	1500	1500	1400	1400	1250	1150	1100
90	1600	1600	1500	1500	1400	1250	1200
110	1900	1800	1700	1700	1600	1400	1400
125	2100	2000	1800	1800	1700	1600	1600

The fixed supports shall be placed so that the thermal changes in the length of the pipeline section between them do not exceed the compensating capacity of taps and expansion joints located in this section and are distributed in proportion to their compensating capacity.

In cases when thermal changes in the length of the pipeline section exceed the compensating ability of its limiting elements, an additional expansion joint shall be installed thereon. In order to avoid transferring the weight to the pipeline, shut-off valves and water distribution valves shall be rigidly fixed on building structures.

1.12. Installation of PP-R pipelines

The traditional method of connecting pressure pipelines made of polypropylene is welding, which consists in heating parts to a viscous state, joining them under a certain pressure and then cooling the parts until a permanent connection is formed.

The most commonly used welding method is socket welding, in which the ends of the pipes are connected through an intermediate piece to the socket

1.12.1. Welding machine

For welding of small diameter pipes, a set of welding equipment is used, which includes:

- welding machine with clamp (power 1500 W);
- replaceable welding heating adaptors (D 20, 25, 32 and 40 mm);
- cutter for cutting pipes up to 40 mm;
- leveller *;
- tape measure
- metal suitcase;
- operation manual
- plugs (2 pcs.)

* depending on the welding machine type



1.12.2. Tool preparation

1. Install the welding machine on a flat surface.
2. Fasten replaceable welding adaptors of the desired size on the welding machine using special keys. Welding adaptors shall fit snugly to the heating element (it is necessary to ensure that the surface of the welding adaptors do not protrude beyond the edge of the heating element).
3. Check the set temperature on the device (welding temperature for PP-R is 260–270 °C).
4. Turn on the welding machine in the network and check whether the warning light is on.
5. Depending on the ambient temperature, the heating of the heating element lasts 10 to 15 minutes. Working temperature on the surface is reached automatically. The heating process is completed when the temperature control lamp turns off or lights up (depending on the type of welding machine). The first welding is recommended to be performed 5 minutes after the welding machine is heated.

(!) ATTENTION:

Welding adaptors shall be kept clean. If necessary, clean the sleeve and core with solvent with a coarse cloth.

1.12.3. Socket welding of parts

The socket welding process includes simultaneous heating of the parts to be joined, technological exposure, removal of parts from the welding adaptors, their interfacing and subsequent natural cooling of the welded parts. For each outer diameter, matched pairs of welding adaptors are selected.



Welding procedure:



1. The welding adaptors of the appropriate diameter are installed on the welding machine after making sure that the working surfaces of the welding adaptors are degreased with acetone or an aqueous solution of alcohol. In cases of sticking of polymer residues from the previous welding, it is necessary to clean the working surfaces.
2. The welding machine is connected to the network and it is expected to be ready for work.
3. The appropriate welding temperature for PP-R is 260 - 270 °C.
4. The pipe is cut at a right angle to the axis of the pipe using a pipe cutter.
5. Before welding, if necessary, end of the pipe and fitting socket are cleaned of moisture, dust and dirt and degreased. For aluminium foiled PP-R pipes, before welding, the end of the pipe is cleaned by outer PP-R layer along with the foil. After shaving, outer the diameter of the pipe shall be within the tolerances of the standard outer diameter of this size.
6. A mark is placed on the pipe at a distance equal to the depth of the socket plus 2 mm.
7. The ends of the parts, by axial movement, without rotating, are smoothly inserted into the welding adaptors.

8. The regulated warm-up time is maintained to a viscous state (according to table 14).
9. Pipe and fitting are removed from the welding adaptors and within 1 - 2 seconds, weld with each other. In this operation, the rotational movements of the parts relative to each other are not allowed; only a small adjustment of the final arrangement of the parts in the final stage of welding is possible.
10. Cooling of welded joints and parts is carried out in a natural way.

(!) ATTENTION:

- During operation, if necessary, welding adaptors are cleaned of adhered material;
- To ensure high-quality connection of parts, damage to the coating of welding adaptors shall be avoided;
- It is strictly forbidden to cool the device with water, otherwise thermal resistances may be damaged.

Table 14. Process parameters of socket welding of PP-R parts (ambient temperature 20 °C)

Outer pipe diameter mm	Welding section length	Heating Time, s	Max Time to Welding after Heating	Cooling Time, min
16	13	5 – 8	4	2
20	14	6 – 8	4	2
25	15	7 – 11	4	2
32	16,5	8 – 12	6	4
40	18	12 – 18	6	4
50	20	18 – 27	6	4
63	24	24 – 36	8	6
90	29	40 – 60	8	8
110	35	60-80	10	10
125	40	80-100	14	14

Welding of thermoplastics is accompanied by the obligatory extrusion of a material called “burr” in the place of the weld melt. When socket welding, the burr exits to the outer surface of the pipe and the inner surface of the connecting part.

1.13. PIPING SYSTEMS TESTS

1.13.1. Water Supply Systems

Domestic cold and hot water supply systems shall be tested by a hydrostatic or manometric method in compliance with the requirements of GOST 24054-80, GOST 25136-82 (Change to ISO norms). The value of the test pressure in the hydrostatic test method shall be equal to 1.5 times the excess operating pressure.

Hydrostatic and manometric tests of systems for cold and hot water shall be carried out prior to the installation of water taps.

The systems are considered to have passed the tests if within 10 minutes of being under test pressure with the hydrostatic test method, no pressure drop of more than 0.05 MPa (0,5 kgf / cm²) and no drops in the welding points, pipes, threaded connections, fixings and water through flush devices. At the end of testing by the hydrostatic method, it is necessary to release water from the systems of domestic cold and hot water supply.

Gauge tests of the internal cold and hot water system shall be performed in the following sequence:

- fill the system with test air with an excess pressure of 0.15 MPa (1.5 kgf / cm²);
- if there are defects in the installation by ear, reduce the pressure to atmospheric pressure and eliminate defects;
- then the system shall be filled with air with a pressure of 0.1 MPa (1 kgf / cm²),
- Hold it under test pressure for 5 minutes.

The system is deemed to have passed the test when it is under test pressure, the pressure drop does not exceed 0.01 MPa (0.1 kgf / cm²).

1.13.2. Heating Systems

Hydrostatic method with a pressure of 1.5 operating pressure but not less than 0.2 MPa (2 kgf / cm²) at the lowest point of the system.

The system is recognized to pass the test if within 5 minutes of finding it under test pressure the pressure drop does not exceed 0.02 MPa (0.2 kgf / cm²) and there are no leaks in the welds, pipes, threaded connections, fittings, heating appliances and equipment.

The value of the test pressure in the hydrostatic test method for heating and heating systems connected to the heating devices shall not exceed the test pressure limit for the heaters installed in the system and the heating and ventilation equipment.

Gauge tests of heating and heat supply systems correspond to the gauge tests of the systems of domestic cold and hot water supply and are performed in the same sequence (paragraph 8.1).

Panel heating systems shall be tested, as a rule, by the hydrostatic method. Gauge test is allowed to be performed at negative outdoor temperature. Hydrostatic testing of panel heating systems shall be carried out (prior to installation of installation windows) with a pressure of 1 MPa (10kgs / cm²) for 15 minutes, while the pressure drop is not more than 0.01 MPa (0.1 kgf / cm²).

For systems of panel heating combined with heating devices, the test pressure shall not exceed the test pressure limit for the heating devices installed in the system. The value of the test pressure of the systems of panel heating, steam heating systems and heat supply for manometric tests shall be 0.1 MPa (1 kgf / cm²). Test duration -5 min. The pressure drop shall be no more than 0.01 MPa (0.1 kgf / cm²).

The system is recognized as having passed the test pressure if subjected for 5 minutes to test pressure the pressure drop does not exceed 0.02 MPa (0.2 kgf / cm²) and there are no leaks in the welds, pipes, threaded connections, fittings, heating appliances.

1.14. Pipe Insulation

Heat insulation of water supply pipelines is carried out in accordance with the requirements of SP 61.13330.2012 "Heat insulation of equipment and pipelines". Updated version of SNiP 41-03-2003. When installing cold water supply systems, it is necessary to protect pipelines from condensation. The minimum insulation thickness for polypropylene pipes can be determined according to Table 15:

Table 15. Recommendations for the pipeline insulation using materials from expanded polyethylene Energoflex.

D out. of the pipe mm	Field of application	Open application (insulation in 2 m tubes)	Installation in construction structure (insulation in 2 m tubes)	Installation in construction structure (insulation in 10 m reels)
16	Heating	Energoflex Super Tube 18/13-2	Energoflex Super Tube Protect-K 18/9-2	Energoflex Super Tube Protect-K 18/4-10
	Hot water supply	Energoflex Super Tube 18/9-2	Energoflex Super Tube Protect-K 18/9-2	Energoflex Super Tube Protect-K 18/4-10
	Cold water supply	Energoflex Super Tube 18/6-2	Energoflex Super Tube Protect-K18/6-2	Energoflex Super Tube Protect-K 18/4-10
	Refrigeration supply (+5 °C – +7 °C)	Energoflex Super Tube 18/9-2	Energoflex Super Tube Protect-K18/9-2	Energoflex Super Tube Protect-K18/4-10
20	Heating	Energoflex Super Tube 22/13-2	Energoflex Super Tube Protect-K 22/9-2	Energoflex Super Tube Protect-K 22/4-10
	Hot water supply	Energoflex Super Tube 22/9-2	Energoflex Super Tube Protect-K 22/9-2	Energoflex Super Tube Protect-K 22/4-10
	Cold water supply	Energoflex Super Tube 22/6-2	Energoflex Super Tube Protect-K 22/6-2	Energoflex Super Tube Protect-K 22/4-10
	Refrigeration supply (+5 °C – +7 °C)	Energoflex Super Tube 22/9-2	Energoflex Super Tube Protect-K 22/9-2	Energoflex Super Tube Protect-K 22/4-10
25	Heating	Energoflex Super Tube 25/13-2	Energoflex Super Tube Protect-K 28/9-2	Energoflex Super Tube Protect-K 28/4-10
	Hot water supply	Energoflex Super Tube 25/9-2	Energoflex Super Tube Protect-K 28/9-2	Energoflex Super Tube Protect-K 28/4-10
	Cold water supply	Energoflex Super Tube 25/6-2	Energoflex Super Tube Protect-K 28/6-2	Energoflex Super Tube Protect-K 28/4-10
	Refrigeration supply (+5 °C – +7 °C)	Energoflex Super Tube 25/9-2	Energoflex Super Tube Protect-K 28/9-2	Energoflex Super Tube Protect-K 28/4-10
32	Heating	Energoflex Super Tube 35/13-2	Energoflex Super Tube Protect-K 35/9-2	Energoflex Super Tube Protect-K 35/4-10
	Hot water supply	Energoflex Super Tube 35/9-2	Energoflex Super Tube Protect-K 35/9-2	Energoflex Super Tube Protect-K 35/4-10
	Cold water supply	Energoflex Super Tube 35/6-2	Energoflex Super Tube Protect-K 35/6-2	Energoflex Super Tube Protect-K 35/4-10
	Refrigeration supply (+5 °C – +7 °C)	Energoflex Super Tube 35/9-2	Energoflex Super Tube Protect-K 35/9-2	Energoflex Super Tube Protect-K 35/4-10
40	Heating	Energoflex Super Tube 42/20-2	Energoflex Super Tube 42/20-2	
	Hot water supply	Energoflex Super Tube 42/9-2	Energoflex Super Tube 42/9-2	
	Cold water supply	Energoflex Super Tube 42/9-2	Energoflex Super Tube 42/9-2	
	Refrigeration supply (+5 °C – +7 °C)	Energoflex Super Tube 42/9-2	Energoflex Super Tube 42/9-2	
50	Heating	Energoflex Super Tube 54/20-2	Energoflex Super Tube 54/20-2	
	Hot water supply	Energoflex Super Tube 54/9-2	Energoflex Super Tube 54/9-2	
	Cold water supply	Energoflex Super Tube 54/9-2	Energoflex Super Tube 54/9-2	
	Refrigeration supply (+5 °C – +7 °C)	Energoflex Super Tube 54/9-2	Energoflex Super Tube 54/9-2	

63	Heating	Energoflex Super Tub 64/20-2	Energoflex Super Tub 64/20-2	
	Hot water supply	Energoflex Super Tub 64/9-2	Energoflex Super Tub 64/9-2	
	Cold water supply	Energoflex Super Tub 64/9-2	Energoflex Super Tub 64/9-2	
	Refrigeration supply (+5 °C – +7 °C)	Energoflex Super Tub 64/9-2	Energoflex Super Tub 64/9-2	
Connection of seams insulation	Energoflex glue 0,5; 0,9; 2,8 L.	Approximate glue consumption:		
		Facility	Approximate consumption of 1 liter of glue	
		Tubes 6 mm thick	Transverse seams ~ 1800 m, Longitudinal seams ~ 200 m	
		Tubes 9 mm thick	Transverse seams ~ 1350 m, Longitudinal seams ~ 150 m	
		Tubes 13 mm thick	Transverse seams ~ 500 m, Longitudinal seams ~ 100 m	
Connection of longitudinal of seams insulation	Clamps	Approximate consumption: 3-5 clamps per 1 running meter of insulation		
		Approximate consumption: The length of straight sections of pipeline multiplied by a factor of 1.2		

Note

The thickness of the heat-insulating layer arranged using Energoflex Super products without coating in the heat-insulating structures for equipment and pipelines located indoor is designed for the following conditions. The design temperature of the heat carrier for the temperature mode of heating networks is 95 °C -70 °C, for hot water supply 70 °C, for cold water supply 10 °C. The indoor temperature is 20 °C, the relative air humidity is 70%. Operating hours per year – less than 5000 Thermal insulation is used without a metallised coating.

1.15. Transportation and storage of PP-R pipes

According to SP 40-101-96, transportation, loading and unloading of polypropylene pipes shall be carried out at an outdoor temperature not lower than -10 °C. Their transportation at temperatures up to -20 °C is allowed only with the use of special devices that ensure the fixation of pipes, as well as taking special precautions.

Pipes and fittings shall be protected from shocks and mechanical loads, and their surfaces from scratches. When transporting, PP-R pipes shall be laid on a flat surface of vehicles so to protect from contacts with sharp metal corners and platform ribs.

Pipes and fittings made of PP-R, delivered to the facility in winter, shall be maintained at a positive temperature for at least 2 hours before their use in buildings.

Pipes shall be stored on racks in closed premises or under sheds. The stockpile height shall not exceed 2 m. Pipes and fittings shall be stored no closer than 1 m from heating appliances.

1.16. Safety Requirements

Upon contact with open fire, the pipe material burns with a soiling flame to form a melt and release carbon dioxide, steam, unsaturated hydrocarbons and gaseous products. Welding of pipe fittings shall be carried out in a ventilated premise.

The welding machine shall be operated in strict compliance with rules of work with the electric tool.



1.17. Normative References

1. GOST 32415-2013 "Pressure pipes made of thermoplastics and pipeline fittings for water supply and heating systems.
2. GOST R 53630-2015 "Multilayer pressure pipes for water supply and heating systems."
3. SP 60.13330.2012 Heating, Ventilation, and Air Conditioning. Updated version of SNiP 41-01-2003».
4. SP 30.13330.2012 Internal Water Supply and Sewage Systems for Buildings Updated version of SNiP 2.04.01-85*».
5. SP 73.13330.2012 "Interior Plumbing and Engineering Systems of buildings" Updated version of SNiP 3.05.01-85.
6. SP 61.13330.2012 Thermal insulation of equipment and pipelines. Updated version of SNiP 41-03-2003.
7. TU 2248-002-16965449-2016 "Pressure pipes and pipeline fittings made from polypropylene random copolymer (PP-R/PP-R-GF/PP-R).
8. TU 2248-001-16965449-2016 "Fiberglass reinforced pressure pipes made of polypropylene random copolymer (PP-R).

ANNEX 1

Chemical Resistance of Pipes and Fittings made of PPR (According to ISO/TR 10358:1993 Plastics pipes and fittings – Combined chemical-resistance classification table)

Legend:

- R – resistant;
- CR – conditionally resistant;
- NR – not resistant;
- No data on the chemical resistance is available.

Symbols relating to concentration of the flowing substances:

- VL – aqueous solution with chemical substance content less than 10%;
- L -- aqueous solution, with chemical substance content greater than 10 %;
- GL – saturated (at 20 °C) aqueous solution;
- C – commercial estimation;
- TR – technically pure.

PP-R PIPES AND FITTINGS FOR WATER SUPPLY AND HEATING

Flowing Substance (corrosive medium)	Concentration	Chemical resistance at		
		20 °C	60 °C	100 °C
Ethyl aldehyde	TR	CR	—	—
Acetophenone	TR	R	R	—
Acetic acid anhydride	TR	R	—	—
Acetic acid Diluted	TR	R	CR	NR
Acetic acid Diluted	40%	R	R	—
Acetone	TR	R	—	—
Acidic acetic anhydride	40%	R	R	—
Acrylonitrile	TR	R	CR	—
Adipinic acid	TR	R	R	—
Air	TR	R	R	R
Alum Me - Me III	GL	R	R	—
Allyl alcohol, Diluted	96%	R	R	—
Alum	TR	R	R	—
Aluminum chloride	GL	R	R	—
Aluminum sulphate	GL	R	R	—
Succinic acid	GL	R	R	—
Diamino ethanol	TR	R	—	—
Ammonia gas	TR	R	R	—
Ammonia, liquid	TR	R	R	—
Aniline	TR	R	—	—
Ammonia, aqueous	GL	R	R	—
Ammonium Acetate	GL	R	R	—
Ammonium carbonate	GL	R	R	—
Ammonium chloride	GL	R	—	—
Ammonium fluoride	L	R	R	—
Ammonium nitrate	GL	R	R	R
Ammonium phosphate	GL	R	R	R
Ammonium sulphate	GL	R	R	R
Amyl Amylacetate	TR	CR	R	—
Amyl alcohol	TR	R	—	R
Aniline	TR	CR	R	—
Aniline Hydrochloride	GL	C	CR	—
Cyclohexanone	TR	CR	C	—
Cyclohexanone	TR	CR	CR	NR

Flowing Substance (corrosive medium)	Concentration	Chemical resistance at		
		20 °C	60 °C	100 °C
Antifreeze Agent	H	R	NR	R
Antimony (III) chloride	90%	R	R	—
Malic acid	L	R	R	—
Malic acid	GL	R	R	—
Apple wine (ortho)	H	R	R	—
Aqua regia (nitrohydrochloric acid)	H	R	R	R
Arcenical acid	40%	R	R	—
Arcenical acid	80%	R	R	CR
Barium hydroxide	GL	R	R	R
Barium salts	GL	R	R	R
Battery acid (electrolytic acid)	H	R	R	—
Beer	H	R	R	R
Aldehyde	GL	R	R	—
Mixture of gasoline and Benzene	8090/2009	CR	NR	NR
Benzene	TR	CR	NR	NR
Benzyl chloride	TR	RR	—	—
Borax (sodium tetraborate)	L	R	R	—
Boric acid	GL	R	R	R
Bromine	TR	NR	NR	NR
Bromine vapors	Any	CR	NR	NR
Butadiene, gas	TR	CR	NR	NR
Butane (2) diol (1,4)	TR	R	R	—
Butandiol	TR	R	R	—
Butanetriol (1,2,4)	TR	R	R	—
Butyne (2) diol (1,4)	TR	R	—	—
Butyl acetate	TR	RR	NR	NR
Butyl alcohol	TR	R	CR	CR
Butyl phenol	GL	R	—	—
Butyl phenol	TR	NR	—	—
Butylene glycol	10%	R	CR	—
Butylene glycol	TR	R	—	—
Butylene, liquid	TR	CR	—	—

Flowing Substance (corrosive medium)	Concentration	Chemical resistance at		
		20 °C	60 °C	100 °C
Carbon monoxide	Any	R	R	—
Carbon disulphide	TR	NR	NR	NR
Sodium hydroxide	60%	R	R	R
Trichloroacetaldehyde	TR	R	R	—
Chloramine	L	R	—	—
Chloroethanol	TR	R	R	—
Chloric acid	1%	R	CR	NR
Chloric acid	10%	R	CR	NR
Chloric acid	20%	R	NR	NR
Chlorine	0.5%	CR	—	—
Chlorine	1%	NR	NR	NR
Chlorine	GL	CR	NR	NR
Chlorine, gas	TR	NR	NR	NR
Chlorine, aqueous	TR	NR	NR	NR
Chloroacetic acid	L	R	R	—
Chlorobenzene	TR	CR	—	—
Chloroform	TR	CR	NR	NR
Chlorosulfonic acid	TP	NR	NR	NR
Chromic acid	40%	CR	CR	NR
Chromic acid/ sulfuric acid / water	15/35/ 50%	NR	NR	NR
Crotonic aldehyde	TR	R	—	—
Citric acid	VL	R	R	R
Citric acid	VL	R	R	R
City gas	C	R	—	—
Coconut fatty alcohol	TR	R	CR	—
Coconut oil	TR	R	—	—
Cognac	C	R	R	—
Copper (II) chloride	GL	R	R	—
Copper Cyanide (I)	GL	R	R	—
Copper Nitrate (II)	30%	R	R	R
Copper sulphate	GL	R	R	—
Corn oil	TR	R	CR	—
Cottonseed oil	TR	R	R	—

Flowing Substance (corrosive medium)	Concentration	Chemical resistance at		
		20 °C	60 °C	100 °C
Cresol	90%	R	R	—
Cresol	>90%	R	—	—
Cyclohexane	TR	R	—	—
Cyclohexanol	TR	R	CR	—
Cyclohexanone	TR	CR	NR	NR
Dextrin	L	R	R	—
Glucose	20%	R	R	R
1,2 diamine ethane	TR	R	R	—
Dichloroacetic acid	TR	CR	—	—
Dichloroacetic acid	50%	R	R	—
Dichlorobenzene	TR	CR	—	—
Dichlorethylene	TR	CR	—	—
Diesel grease	C	R	CR	—
Diethylamine	TR	R	—	—
Diethyl ether	TR	R	CR	—
Diglycolic acid	GL	R	R	—
Dihexyl phthalate	TR	R	CR	—
Diisooctyl phthalate	TR	R	CR	—
Diisopropyl ether	TR	CR	NR	—
Dimethyl formamide	TR	R	R	—
Dimethyl amine	100%	R	—	—
Di-n butyl ether	TR	R	CR	—
Dinonyl phthalate	TR	R	CR	—
Diocetyl phthalate	TR	R	CR	—
Dioxane	TR	CR	CR	—
Potable water	TR	R	R	R
Ethanol	L	R	R	—
Ethanol + 2% of toluene	96%	R	—	—
Ethyl acetate	TR	R	CR	NR
Ethyl alcohol	TR	R	R	R
Ethyl benzene	TR	CR	NR	NR
Ethyl chloride	TR	NR	NR	NR
Ethylene diamine	TR	R	R	—
Ethylene glycol	TR	R	R	R

PP-R PIPES AND FITTINGS FOR WATER SUPPLY AND HEATING

Flowing Substance (corrosive medium)	Concentration	Chemical resistance at		
		20 °C	60 °C	100 °C
Hydrofluosilicic acid	32%	R	R	—
Formaldehyde	40%	R	R	—
Formic acid	10%	R	R	CR
Formic acid	85%	R	CR	NR
Fructose	—	R	R	R
Fruit juices	H	R	R	R
Furfuryl alcohol	TR	R	CR	—
Gelatin	L	R	R	R
Glucose	20%	R	R	R
Glycerol	TR	R	R	R
Glycolic acid	30%	R	CR	—
Rendered animal fat	H	CR	—	—
HCl/HNO ₃	75%/25%	NR	NR	NR
Heptane	TR	R	CR	NR
Hexane	TR	R	CR	—
Hexanetriol (1, 2, 6)	TR	R	R	—
Hydrazine hydrate	TR	R	—	—
Hydrofluoric acid	40%	R	CR	NR
Hydrochloric acid	20%	R	R	—
Hydrochloric acid	20%-36%	R	CR	CR
Hydrofluoric acid	40%	R	R	—
Hydrofluoric acid	70%	R	CR	—
Hydrogen	TR	R	R	—
Hydrogen chloride	TR	R	R	—
Hydrogen peroxide	30%	R	CR	—
hydrocyanic acid	TR	R	R	—
Sulphate hydroxyl-ammonium	12%	R	R	—
Iodine solution	C	R	CR	—
Isooctane	TR	R	CR	NR
Isopropyl	TR	R	R	R
Kerosene	C	R	CR	NR
a- hydroxy propa-noic acid	90%	R	R	—
Lanolin	C	R	CR	—

Flowing Substance (corrosive medium)	Concentration	Chemical resistance at		
		20 °C	60 °C	100 °C
Lead Acetate	GL	R	R	CR
Flax-seed oil	H	R	R	R
Lubricating oils	TR	R	CR	NR
Magnesium chloride	GL	R	R	R
Hydroxycarbonate of Magnesium	GL	R	NR	NR
Magnesium salts	GL	R	R	—
Magnesium sulfate	GL	R	R	R
Menthol	TR	R	CR	—
Methanol	TR	R	R	—
Methanol	5%	R	R	CR
Methyl acetate	TR	R	R	—
Methylamine	32%	R	—	—
Methyl bromide	TR	NR	NR	NR
Methyl chloride	TR	NR	NR	NR
Methyl ethyl ketone	TR	R	CR	—
Mercury	TR	R	R	—
Mercury salts	GL	R	R	R
Milk	H	R	R	R
Mineral water	H	R	R	R
Molasses	H	R	R	R
Engine oil	TR	R	CR	R
Natural gas	TR	R	—	—
Nickel salts	GL	R	CR	—
Nitric acid	10%	R	CR	NR
Nitric acid	10%-50%	CR	NR	NR
Nitric acid	>50%	NR	NR	NR
2-nitrotoluene	TR	R	CR	—
Nitrous gases	Any	R	R	—
Oleum (fuming sulfuric acid) (H ₂ SO ₄ +SO ₃)	TR	NR	NR	NR
Olive oil	TR	R	R	CR
Ethanedioic acid	GL	R	R	NR
Oxygen	TR	R	—	—
Ozone	0.5 ppm	R	CR	—
Paraffin emulsions	C	R	R	—

Flowing Substance (corrosive medium)	Concentration	Chemical resistance at		
		20 °C	60 °C	100 °C
Oil	TR	R	NR	—
Petroleum	TR	C	NR	—
Petroleum ether	TR	C	NR	—
Phenol	5%	C	C	—
Phenol	90%	C	—	—
Phenylhydrazine	TR	CR	CR	—
Hydrochloride of phenylhydrazine	TR	C	CR	—
Phosgene	TR	CR	CR	—
Phosphates	GL	R	R	—
Phosphoric acid (orthophosphoric)	85%	R	R	R
Oxychloride of phosphorus	TR	CR	—	—
Phthalic acid	GL	R	R	—
Photographic emulsions	H	R	R	—
Baths with photo fixing agent	H	R	R	—
Picric acid	GL	R	—	—
Potassium bichromate	GL	R	R	—
Potassium bromate	10%	R	R	—
Potassium bromide	GL	R	R	—
Potassium carbonate	GL	R	R	—
Potassium chlorate	GL	R	R	—
Potassium chloride	GL	R	R	—
Potassium chromate	GL	R	R	—
Potassium cyanide	L	R	R	—
Potassium fluoride	GL	R	R	—
Potassium bicarbonate	GL	R	R	—
Potassium hydroxide	50%	R	R	R
Potassium iodide	GL	R	R	—

Flowing Substance (corrosive medium)	Concentration	Chemical resistance at		
		20 °C	60 °C	100 °C
Potassium nitrate	GL	R	R	—
Potassium perchlorate	10%	R	R	—
Permanganate of potassium	GL	R	NR	—
Potassium persulphate	GL	R	R	—
Potassium sulfate	GL	R	R	—
Propane gas	TR	R	—	—
Propanol (1)	TR	R	R	—
Propargyl alcohol	7%	R	R	—
Propionic (propanic) acid	>50%	R	—	—
Propylene glycol	TR	R	R	—
Pyridine	TR	NR	NR	—
Sea water	H	C	C	C
Silicic acid	Any	C	C	—
Fluorosilicic acid	32%	C	C	—
Silicone emulsion	H	C	C	—
Silicone oil	TR	C	C	C
Silver nitrate	GL	R	R	CR
Silver salts	GL	R	R	—
Sodium acetate	GL	R	R	R
Sodium benzoate	35%	R	R	—
Hydrocarbonate	GL	R	R	R
Hydrosulphate	GL	R	R	—
Hydrosulfite	L	R	—	—
Sodium carbonate	50%	R	R	CR
Sodium chlorate	GL	R	R	—
Sodium chloride	VL	R	R	R
Sodium chlorite	2 – 20%	C	CR	NR
Sodium chromate	GL	R	R	R
Sodium hydroxide	60%	R	R	R
Hypochloride of sodium	20%	NR	NR	NR
Hypochlorite Of sodium	10%	R	—	—
Hypochlorite of sodium	20%	CR	CR	NR
Sodium nitrate	GL	R	R	—
Sodium silicate	L	R	R	—
Sodium sulphate	GL	R	R	—

Flowing Substance (corrosive medium)	Concentration	Chemical resistance at		
		20 °C	60 °C	100 °C
Sulphur dioxide	Any	R	R	—
Sulphur dioxide gas	TR	R	R	—
Sulphur dioxide liquid	Any	R	R	—
Sulphuric acid	10%	R	R	R
Sulphuric acid	10%-80%	R	R	—
Sulphuric acid	80%-TR	CR	NR	—
Oleum (fuming sulfuric acid)	Any	R	R	—
Sulfur trioxide	Any	R	R	—
Pine tar oil	H	R	NR	NR
Tetrachloro-ethane	TR	CR	NR	NR
Tetrachloro-ethylene	TR	CR	CR	—
Carbon tetrachloride	TR	HR	NR	NR
Tetraethyl lead	TR	R	—	—
Tetrahydrofuran	TR	CR	NR	NR
Tetrahydro-naphthalene	TR	NR	NR	NR
Trionyl chloride	TR	CR	NR	NR
Tin (II) chloride	GL	R	R	—

Flowing Substance (corrosive medium)	Concentration	Chemical resistance at		
		20 °C	60 °C	100 °C
Tin (IV) chloride	GL	R	R	—
Toluene	TR	CR	NR	NR
Trichloroethylene	TR	NR	NR	NR
Trichloro acetyl acid	50%	R	R	—
Tricresyl phosphate	TR	R	CR	—
Triethanolamine	L	R	—	—
Grape vinegar	H	R	R	R
Xylene	TR	CR	NR	NR
Dimethylbenzene	TR			
Yeast	Any	R	—	—
Zinc	GL	R	R	—
Trioctyl phosphate	TR	R	—	—
Urea	GL	R	R	—
Vaseline oil	TR	R	CR	—
Vinegar	H	R	R	R
Vinyl acetate	TR	R	CR	—
Washing detergent	VL	R	R	—
Pure water	H	R	R	R
Wax	H	R	CR	—
Tartaric acid	10%	R	R	—
Wines	H	R	R	—

APPENDIX 2 (FOR INFORMATION)

The maximum allowable operating pressure (during operation of the pipeline at a constant temperature), depending on temperature and service life at a safety factor of C=1,5

Temperature, °C	Service life (years)	Operating Pressure (Mpa)			
		SDR 11	SDR 7,4	SDR 6	SDR 5
20	1	1,5	2,37	2,99	3,77
	5	1,41	2,23	2,81	3,54
	10	1,37	2,17	2,74	3,45
	25	1,32	2,1	2,64	3,33
	50	1,29	2,04	2,57	3,24
40	1	1,08	1,71	2,16	2,72
	5	1,01	1,6	2,02	2,54
	10	0,98	1,55	1,96	2,47
	25	0,94	1,5	1,88	2,37
	50	0,92	1,45	1,83	2,31
60	1	0,77	1,22	1,54	1,94
	5	0,71	1,13	1,43	1,8
	10	0,69	1,1	1,39	1,75
	25	0,66	1,05	1,33	1,67
	50	0,64	1,02	1,29	1,62
70	1	0,65	1,03	1,29	1,63
	5	0,6	0,95	1,2	1,51
	10	0,58	0,92	1,16	1,46
	25	0,5	0,8	1	1,27
	50	0,42	0,67	0,85	1,07
80	1	0,54	0,86	1,08	1,37
	5	0,48	0,76	0,96	1,21
	10	0,4	0,64	0,81	1,02
	25	0,32	0,51	0,65	0,81
95	1	0,38	0,61	0,76	0,96
	5	0,26	0,41	0,52	0,65
	10	0,22	0,34	0,43	0,55

FLANGE CONNECTIONS IN PP-R PIPING SYSTEMS

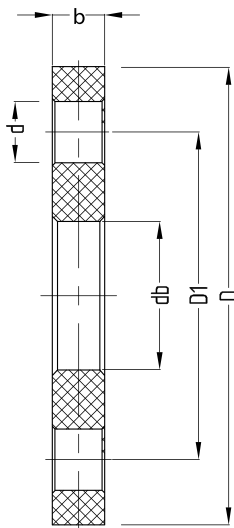

PP-R plastic flange

Dimensions of PP-R Plastic Flange								
Code	DN mm	PN	db	D1	D	b	d	n
PA51220	20	16	28	65	95	11	14	4
PA51225	25	16	34	75	105	12	14	4
PA51232	32	16	42	85	115	14	14	4
PA51240	40	16	51	100	140	15	18	4
PA51250	50	16	62	110	150	15.5	18	4
PA51263	63	16	78	125	165	18	18	4
PA51275	75	16	92	145	185	20	18	4
PA51290	90	16	110	160	200	22	18	8
PA52110	110	16	133	180	220	24	18	8

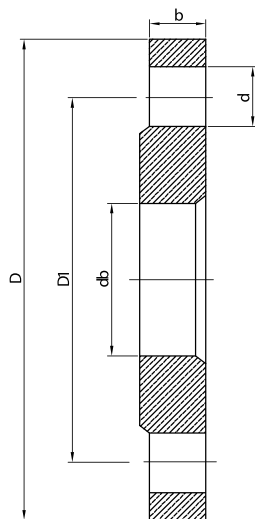

Steel flange

Dimensions of Steel Flange								
Code	DN mm	PN	db	D1	D	b	d	n
223100201	20	16	26	75	105	12	14	4
223100202	25	16	33	85	115	12	14	4
223100203	32	16	39	100	135	14	18	4
223100204	40	16	46	110	145	15	18	4
223100205	50	16	59	125	160	15	18	4
223100206	65	16	78	145	180	17	18	4
223100207	80	16	91	160	195	17	18	8
223100208	100	16	110	180	215	19	18	8
223100209	125	16	135	210	245	21	18	8
223100210	150	16	161	240	280	21	22	8

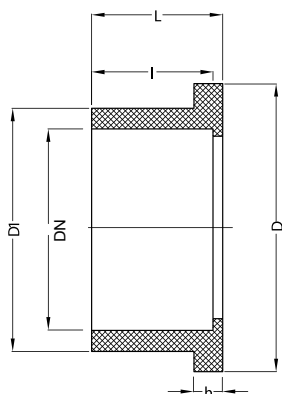

PP-R Neck for Flange

Dimensions of PP-R Neck for Flange							
Code	DN mm	PN	l	L	h	D1	D
PA51120	20	16	16	19	6	27	34
PA51125	25	16	19	21	7	33	41
PA51132	32	16	22	25	7	41	50
PA51140	40	16	26	29	8	50	61
PA51150	50	16	31	34	8	61	73
PA51163	63	16	38	41	9	76	90
PA51175	75	16	44	47	10	90	106
PA51190	90	16	51	56	11	108	125
PA51110	110	16	61	66	12	131	150
PA51125	125	16	69	74	13	148	170

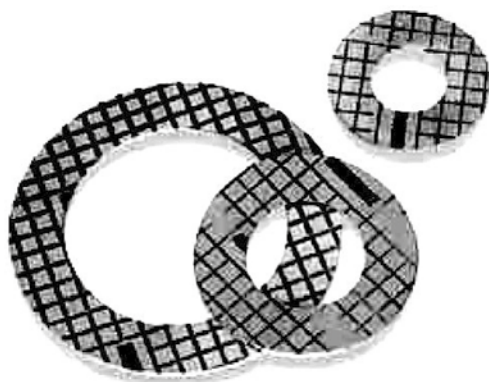

Interflange gaskets

Dimensions of Interflange Gaskets						
Code	DN mm	DN1	D mm	D1 mm	S mm	P r
434015000	15	1/2"	50	20	2	6
434020000	20	3/4"	60	25	2	8
434025000	25	1"	70	30	2	10
434032000	32	1 1/4"	82	38	2	14
434040000	40	1 1/2"	92	45	2	17
434050000	50	2"	108	57	2	22
434065000	65	2 1/2"	127	76	2	27
434080000	80	3"	142	89	2	30
434100000	100	4"	162	108	2	38
434125000	125	5"	192	140	2	44

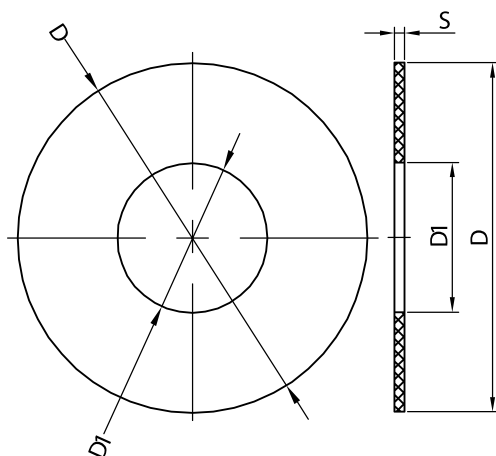

For water supply and heating systems.

Minimum temperature for non-aggressive liquid - 150 °C.

Flange installation – polypropylene flanges

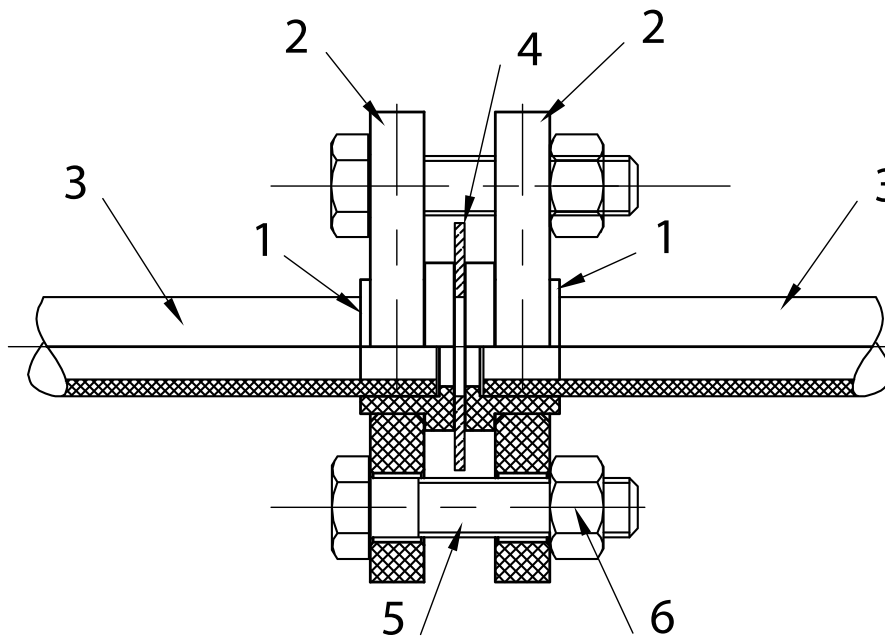

Flange connection – flange neck

NPN	Title	Diameter, mm	Code	Diameter, mm	Code	Diameter, mm	Code	Diameter, mm	Code	Diameter, mm	Code	Quantity
1	Neck	20	PA 51120	25	PA 51125	32	PA 51132	40	PA 51140	50	PA 51150	2
2	Polypropylene Flange	20	PA51220	25	PA51225	32	PA51232	40	PA51240	50	PA51250	2
3	SDR 11(PN 10) pipes	20	PA 11008	25	PA 11010	32	PA 11012	40	PA 11014	50	PA 11016	1
	SDR 6(PN 20) pipes		PA 10008		PA 10010		PA 10012		PA 10014		PA 10016	1
	SDR 5(PN 25) pipes		PA 30008PR		PA 30010 PR		PA 30012 PR		PA 30014 PR		PA 30016 PR	1
	"Rubis" SDR 7,4 pipes		PA 35008P		PA 35010 P		PA 35012 P		PA 35014 P		PA 35016 P	1
	"Rubis" SDR 6 pipes		PA 37008P		PA 37010 P		PA 37012 P		PA 37014 P		PA 37016 P	1
4	Gaskets	15	434015000	20	434020000	25	434025000	32	434032000	40	434040000	1
5	Bolt	M12x70	ZCD1270	M12x70	ZCD1270	M12x70	ZCD1270	M16x80	ZCD1680	M16x80	ZCD1680	4
6	Screw-nut	M12	NUT00121	M12	NUT00121	M12	NUT00121	M16	NUT00161	M16	NUT00161	4

NPN nn	Title	Diameter, mm	Code	Diameter, mm	Code	Diameter, mm	Code	Diameter, mm	Code	Diameter, mm	Code	Quantity
1	Neck	63	PA 51163	75	PA51175	90	PA 51190	110	PA 51110	125	PA 51125	2
2	Polypropylene Flange	63	PA51263	75	PA51275	90	PA51290	110	PA51210	125	PA51225	2
3	SDR 11(PN 10) pipes	63	PA 11018	75	PA11020	90	PA 11022	110	PA 11024	125	PA 11026	1
	SDR 6(PN 20) pipes		PA 10018		PA10020		PA 10022		PA 10024		PA 10026	1
	SDR 5(PN 25) pipes		PA 30018PR		PA30020pr		PA 30022 PR		PA 30024 PR		PA 30026 PR	1
	"Rubis" SDR 7,4 pipes		PA 35018P		PA35020P		PA 35022 P		PA 35024 P		PA 35026 P	1
	"Rubis" SDR 6 pipes		PA 37018P		PA37020P		PA 37022 P		PA 37024 P		PA 37026 P	1
4	Gaskets	50	434050000	65	434060000	80	434080000	100	434100000	125	434125000	1
5	Bolt	M16x90	ZCD1690	M16x100	ZCD16100	M16x100	ZCD16100	M16x120	ZCD16120	M16x120	ZCD16120	8
6	Screw-nut	M16	NUT00161	M16	NUT00161	M16	NUT00161	M16	NUT00161	M16	NUT00161	8

Flange connection – flanges, polypropylene - steel

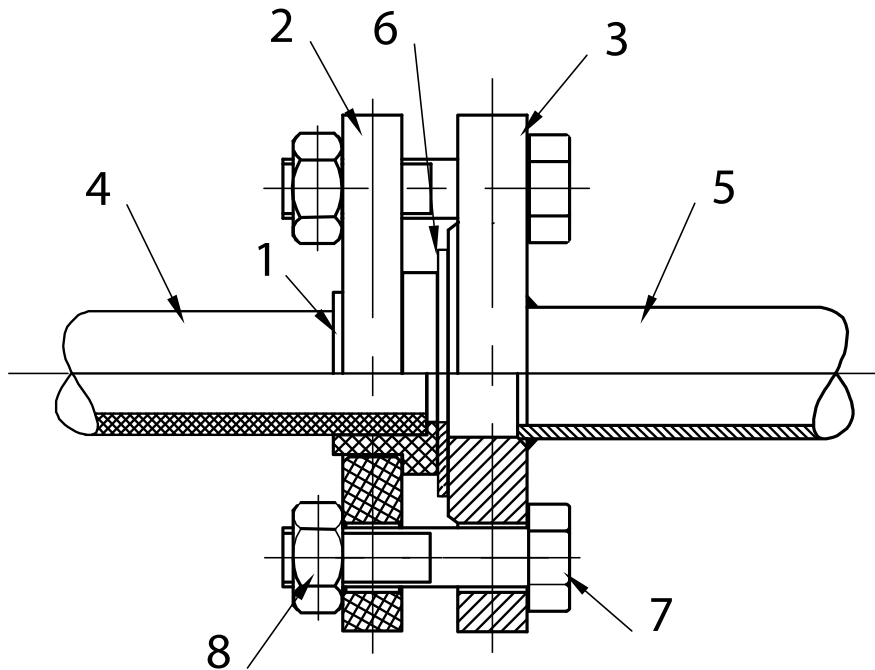

Flange connection – flange neck

N°P	Title	Diameter, mm	Code	Diameter, mm	Code	Diameter, mm	Code	Diameter, mm	Code	Diameter, mm	Code	Quantity
1	Neck	20	PA 51120	25	PA 51125	32	PA 51132	40	PA 51140	50	PA 51150	1
2	Polypropylene Flange	20	PA51220	25	PA51225	32	PA51232	40	PA51240	50	PA51250	1
3	SDR 11(PN 10) pipes	15	223100200	20	223100210	25	223100202	32	223100203	40	223100204	1
4	SDR 11(PN 10) pipes	20	PA 11008	25	PA 11010	32	PA 11012	40	PA 11014	50	PA 11016	1
	SDR 6(PN 20) pipes		PA 10008		PA 10010		PA 10012		PA 10014		PA 10016	1
	SDR 5(PN 25) pipes		PA 30008PR		PA 30010 PR		PA 30012 PR		PA 30014 PR		PA 30016PR	1
	"Rubis" SDR 7,4 pipes		PA 35008P		PA 35010 P		PA 35012 P		PA 35014 P		PA 35016P	1
	"Rubis" SDR 6 pipes		PA 37008P		PA 37010 P		PA 37012 P		PA 37014 P		PA 37016P	1
5	Steel water gas pipe	15		20		25		32		40		1
6	Gaskets	15	434015000	20	434020000	25	434025000	32	434032000	40	434040000	1
7	Bolt	M12x70	ZCD1270	M12x70	ZCD1270	M12x70	ZCD1270	M16x80	ZCD1680	M16x80	ZCD1680	4
8	Screw-nut	M12	NUT00121	M12	NUT00121	M12	NUT00121	M16	NUT00161	M16	NUT00161	4

N°P	Title	Diameter, mm	Code	Diameter, mm	Code	Diameter, mm	Code	Diameter, mm	Code	Diameter, mm	Code	Quantity
1	Neck	63	PA 51163	75	PA51175	90	PA 51190	110	PA 51110	125	PA 511125	1
2	Polypropylene Flange	63	PA51263	75	PA51275	90	PA51290	110	PA512110	125	PA512125	1
3	SDR 11(PN 10) pipes	50	223100200	65	223100206	80	223100202	100	223100203	125	223100204	1
4	SDR 11(PN 10) pipes	63	PA 11018	75	PA11020	90	PA 11022	110	PA 11024	125	PA 11026	1
	SDR 6(PN 20) pipes		PA 10018		PA10020		PA 10022		PA 10024		PA 10026	1
	SDR 5(PN 25) pipes		PA 30018PR		PA30020PR		PA 30022 PR		PA 30024 PR		PA 30026 PR	1
	"Rubis" SDR 7,4 pipes		PA 35018P		PA35020P		PA 35022 P		PA 35024 P		PA 35026 P	1
	"Rubis" SDR 6 pipes		PA 37018P		PA37020P		PA 37022 P		PA 37024 P		PA 37026 P	1
5	Steel water gas pipe	50		65		80		100		125		1
6	Gaskets	50	434050000	65	434065000	80	434080000	100	434100000	125	434125000	1
7	Bolt	M16x90	ZCD1690	M16x100	ZCD16100	M16x100	ZCD16100	M16x120	ZCD16120	M16x120	ZCD16120	8
8	Screw-nut	M16	NUT00161	M16	NUT00161	M16	NUT00161	M16	NUT00161	M16	NUT00161	8

PRODUCT RANGE: PIPES, FITTINGS, TOOLS

Polypropylene pipes and fittings are made in three colors, green, white and gray. Last digit of product code indicates the color where V means green, B means white and G means gray color.

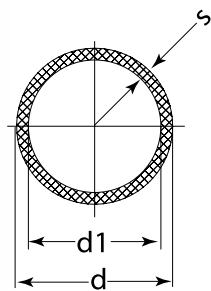

Pipe SDR 11 cold water

d, mm	d1, mm	s, mm	Pack Quantity	Code
20	16,2	1,9	100	PA11008v
25	20,4	2,3	80	PA11010v
32	26,0	2,9	60	PA11012v
40	32,6	3,7	40	PA11014v
50	40,8	4,6	24	PA11016v
63	51,4	5,8	16	PA11018v
75	61,2	6,9	12	PA11020v
90	73,6	8,2	8	PA11022v
110	90	10	4	PA11024v
125	102,2	11,4	4	PA11026v

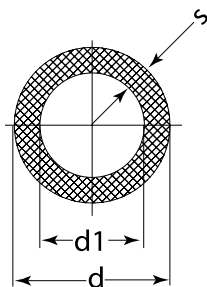

Pipe SDR 6 hot water

20	13,2	3,4	100	PA10008v
25	16,6	4,2	80	PA10010v
32	21,2	5,4	60	PA10012v
40	26,6	6,7	40	PA10014v
50	33,2	8,3	24	PA10016v
63	42,0	10,5	16	PA10018v
75	50,0	12,5	12	PA10020v
90	60,0	15,0	8	PA10022v
110	73,2	18,3	4	PA10024v
125	83,2	20,8	4	PA10026v

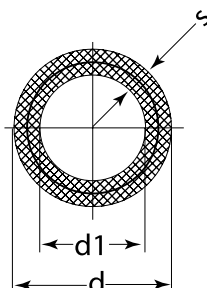

Pipe fibre reinforced RUBIS SDR 7,4 hot water

20	14,4	2,8	100	PA35008Pv
25	18,0	3,5	80	PA35010Pv
32	23,2	4,4	60	PA35012Pv
40	29,0	5,5	40	PA35014Pv
50	36,2	6,9	24	PA35016Pv
63	45,8	8,6	16	PA35018Pv
75	54,4	10,3	12	PA35020Pv
90	65,4	12,3	8	PA35022Pv
110	79,8	15,1	4	PA35024Pv
125	90,8	17,1	4	PA35026Pv

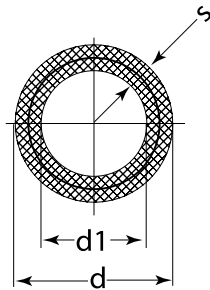

Pipe fibre reinforced RUBIS SDR 6 hot water

d, mm	d1, mm	s, mm	Pack Quantity	Code
20	13,2	3,4	100	PA37008Pv
25	16,6	4,2	80	PA37010Pv
32	21,2	5,4	60	PA37012Pv
40	26,6	6,7	40	PA37014Pv
50	33,2	8,3	24	PA37016Pv
63	42,0	10,5	16	PA37018Pv
75	50,0	12,5	12	PA37020Pv
90	60,0	15,0	8	PA37022Pv
110	73,2	18,3	4	PA37024Pv
125	83,4	20,8	4	PA37026Pv

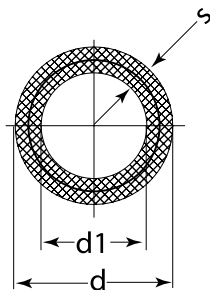

Pipe aluminum reinforced (centre) DUO SDR 6

d, mm	d1, mm	s, mm	Pack Quantity	Code
20	13,2	3,4	100	PA39008v
25	16,6	4,2	80	PA39010v
32	21,2	5,4	60	PA39012v
40	26,6	6,7	40	PA39014v
50	33,2	8,3	24	PA39016v
63	42	10,5	16	PA39018v
75	50	12,5	12	PA39020v

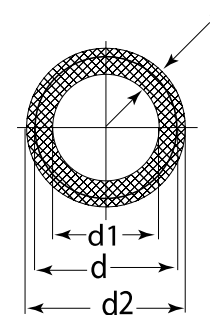

Pipe aluminum reinforced SDR 5

d, mm	d1, mm	d2, mm	s, mm	Pack Quantity	Code
20	13,2	21,2	4,0	100	PA30008prv
25	16,6	26,2	4,8	80	PA30010prv
32	21,2	33,2	6,0	60	PA30012prv
40	26,6	41,4	7,4	40	PA30014prv
50	33,4	52,2	9,4	24	PA30016prv
63	42,0	65,4	11,7	16	PA30018prv
75	50,0	77,4	13,7	12	PA30020Prv
90	60,0	92,9	16,4	8	PA30022Prv
110	73,2	112,2	19,5	4	PA30024Prv

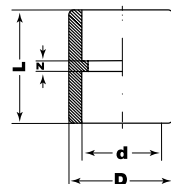

Coupling

d, mm	D, mm	L, mm	Z, mm	Box Quantity	Code
20	29	35.5	6,5	500	PA12008Pv
25	34	38.5	6,5	300	PA12010Pv
32	42	44	8,0	200	PA12012Pv
40	52	47	6,0	100	PA12014Pv
50	65	52	5,0	60	PA12016Pv
63	82	60	6,0	42	PA12018Pv
75	100	66	5,0	24	PA12020Pv
90	120	72	6,0	12	PA12022Pv
110	147	80	6,0	6	PA12024Pv
125	163	88	6,0	6	PA12026Pv

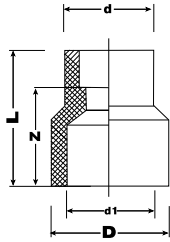

Reducing coupling F/M

d, mm	d1, mm	D, mm	L, mm	Z, mm	Box Quantity	Code
25	20	29	38,5	24,0	500	PA12512Pv
32	20	29	42,5	30,5	300	PA12514Pv
32	25	34	45,0	29,0	300	PA12516Pv
40	20	34	49,5	35,0	200	PA12518Pv
40	25	34	49,5	33,5	200	PA12520Pv
40	32	42	50,0	32,0	200	PA12522Pv
50	20	29	54,5	40,0	120	PA12524Pv
50	25	34	54,5	38,5	120	PA12526Pv
50	32	42	54,5	36,5	100	PA12528Pv
50	40	52	54,5	34,0	80	PA12530Pv
63	25	34	65,0	49,0	90	PA12532Pv
63	32	42	65,0	47,0	60	PA12534Pv
63	40	52	65,0	44,5	60	PA12536Pv
63	50	65	65,0	41,5	48	PA12538Pv
75	50	65	67,5	43,5	36	PA12540Pv
75	63	82	71,5	44,0	24	PA12542Pv
90	63	100	82,0	52,0	18	PA12544Pv
90	75	100	82,0	52,0	18	PA12546Pv
110	75	120	93,0	93,0	12	PA12548Pv
110	90	120	93,0	60,0	10	PA12550Pv
125	110	-	-	-	5	PA12550Pv

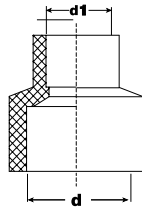

Reducing coupling

d-d1 mm	Box Quantity	Code
25-20	300	PA1261008v
32-20	200	PA1261208v
32-25	210	PA1261210v

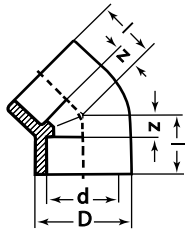

Elbow 45°

d, mm	Box Quantity	Code
20	400	PA13508Pv
25	250	PA13510Pv
32	125	PA13512Pv
40	80	PA13514Pv
50	40	PA13516Pv
63	20	PA13518Pv
75	12	PA13520Pv
90	6	PA13522Pv
110	3	PA13524v
125	2	PA13526Pv

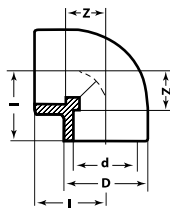

Elbow 90°

d, mm	D, mm	L, mm	Z, mm	Box Quantity	Code
20	29	25,5	11,0	350	PA13008Pv
25	34	30,0	14,0	200	PA13010Pv
32	42	36,0	18,0	100	PA13012Pv
40	52	40,5	20,0	60	PA13014Pv
50	65	49,5	26,0	30	PA13016Pv
63	82	59,5	32,5	20	PA13018Pv
75	100	69,5	39,0	8	PA13020Pv
90	121	79,5	46,5	4	PA13022Pv
110	147	93,0	56,0	2	PA13024Pv
125				2	PA13026Pv

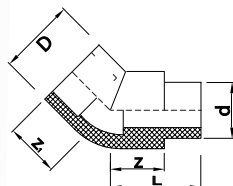

Reducing elbow 45° F/M

d, mm	D, mm	L, mm	Z, mm	Z1, mm	Box Quantity	Code
20	29	25,5	10,5	29,0	200	PA13808v
25	34	30,0	14,0	33,0	100	PA13810v

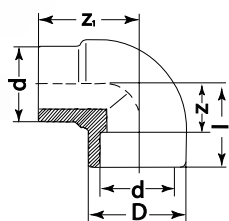

Reducing elbow 90°

d, mm	Box Quantity	Code
25 x 20	200	PA1371008v
32 x 20	200	PA1371208v
32 x 25	100	PA1371210v



Reducing elbow 90° F/M

d, mm	Box Quantity	Code
25 x 20	300	PA13608Pv
32 x 20	175	PA13610Pv
32 x 25	80	PA13612Pv

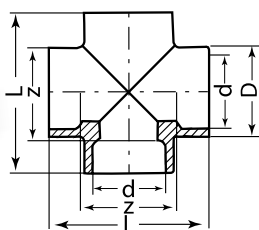

Cross

d, mm	D, mm	L, mm	Z, mm	Box Quantity	Code
20	29	26,5	12,0	150	PA17008Pv
25	34	31,0	15,0	100	PA17010Pv
32	42	36,0	18,0	50	PA17012Pv
40	50			30	PA17014v
50			18,0	6	PA17016v



Reducing cross

d, mm	Code
25 x 20	PA17521v
32 x 25	PA17532v
40 x 32	PA17543v

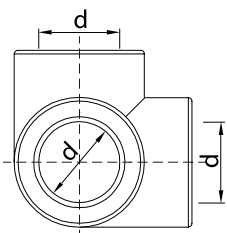

Corner T

d, mm	Box Quantity	Code
20	200	PA17308Pv
25	150	PA17310Pv
32	-	PA17312Pv

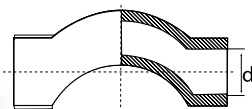

Cross over with socket F/F

d, mm	Box Quantity	Code
20	150	PA16116Pv
25	80	PA16118Pv
32	40	PA16120Pv
40	20	PA16122V

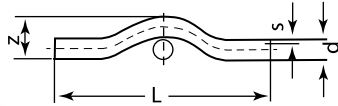

Cross over

d, mm	L, mm	s, mm	z, mm	Box Quantity	Code
20	225	3,4	53	100	PA16008Pv
25	250	4,2	56	50	PA16010Pv
32	280	5,4	68	30	PA16012Pv
40	390	6,7	80	20	PA16014Pv

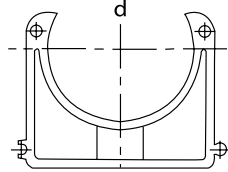

Sleeve

d, mm	Box Quantity	Code
16	800	PA18006Pv
20	500	PA18008Pv
25	400	PA18010Pv
32	300	PA18012Pv
40	350	PA18014Pv
50	200	PA18016Pv
63	200	PA18018Pv

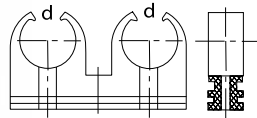

Double sleeve

d, mm	Box Quantity	Code
20	200	PA18508Pv
25	200	PA18510Pv
32	150	PA18512v

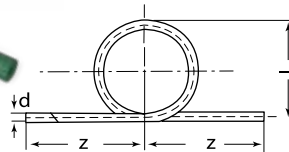

Expansion joint

d, mm	L, mm	l, mm	z, mm	Box Quantity	Code
20	750	130	167	10	PA54008Pv
25	770	140	167	8	PA54010Pv
32	840	160	167	5	PA54012Pv
40	960	180	167	4	PA54014Pv

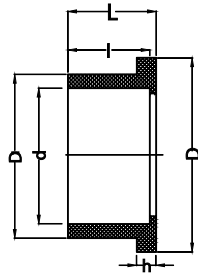

Neck for flange

d, mm	l, mm	L, mm	h, mm	D1, mm	D, mm	Box Quantity	Code
20	16	19	6	27	34	200	PA51120v
25	19	21	7	33	41	250	PA51125v
32	22	25	7	41	50	200	PA51132v
40	26	29	8	50	61	150	PA51140v
50	31	34	8	61	73	100	PA51150v
63	38	41	9	76	90	50	PA51163v
75	44	47	10	90	106	30	PA51175v
90	51	56	11	108	125	20	PA51190v
110	61	66	12	131	150	10	PA51110v
125	69	74	13	148	170	-	PA51125v
160	84	90	16,8	185	210	-	-

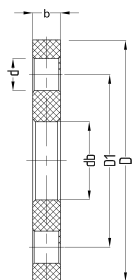

Plastic flange

DN, mm	db, mm	D1, mm	D, mm	b, mm	d, mm	Box Quantity	Code
20	28	65	95	11	14	170	PA51220v
25	34	75	105	12	14	120	PA51225v
32	42	85	115	14	14	110	PA51232v
40	51	100	140	15	18	50	PA51240v
50	62	110	150	15,5	18	25	PA51250v
63	78	125	165	18	18	30	PA51263v
75	92	145	185	20	18	25	PA51275v
90	110	160	200	22	18	15	PA51290v
110	133	180	220	24	18	10	PA52110v

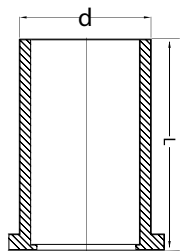

Long neck

d, mm	Box Quantity	Code
20	200	PA64000v

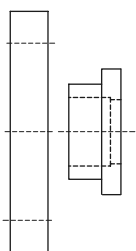

Flange with neck EN 1092

d, mm	Box Quantity	Code
20	1	PA56020v
25	1	PA56025v
32	1	PA56032v
40	1	PA56040v
50	1	PA56050v
63	1	PA56063v
75	1	PA56075v
90	1	PA56090v
110	1	PA56110v

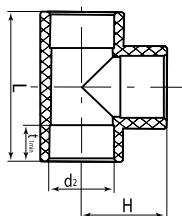

T-Piece

d, mm	D, mm	L, mm	Z, mm	Box Quantity	Code
20	29	50	12,0	200	PA14008Pv
25	34	62	15,0	150	PA14010Pv
32	42	72	18,0	60	PA14012Pv
40	52	81	20,0	40	PA14014Pv
50	65	99	26,0	20	PA14016Pv
63	82	119	32,5	16	PA14018Pv
75	100	139	39,0	8	PA14020Pv
90	121	159	46,5	4	PA14022Pv
110	147	186	56,0	2	PA14024Pv
125	-	-	-	2	PA14026Pv

Reducing T

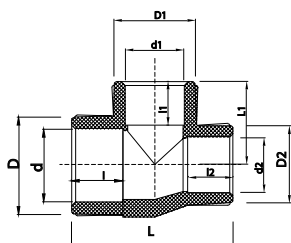

	d, mm	d ₁ , mm	d ₂ , mm	D ₁ , mm	D ₂ , mm	L, mm	L ₁ , mm	l, mm	Box Quantity	Code	
25x20x20	25	20	20	29	34	29	52,9	28,5	16,0	200	PA14520Pv
25x20x25	25	20	25	29	34	34	54,0	30,0	16,0	150	PA14521Pv
32x20x20	32	20	20	29	42	29	76,0	37,0	18,1	80	PA14530Pv
32x20x25	32	20	25	29	42	34	74,8	34,5	18,1	80	PA14531Pv
32x20x32	32	20	32	29	42	42	57,5	34,5	18,1	100	PA14532Pv
32x25x20	32	25	20	34	42	29	75,0	35,0	18,1	80	PA14533Pv
32x25x25	32	25	25	34	42	34	74,7	39,3	18,1	80	PA14534Pv
32x25x32	32	25	32	34	42	42	63,0	32,0	18,1	80	PA14535Pv
40x20x40	40	20	40	29	52	52	64,0	36,0	20,5	80	PA14540Pv
40x25x40	40	25	40	34	52	52	68,0	36,0	20,5	60	PA14541Pv
40x32x40	40	32	40	42	52	52	74,6	38,0	20,5	60	PA14542Pv
50x20x50	50	20	50	29	65	65	74,0	42,9	23,5	40	PA14559Pv
50x25x50	50	25	50	34	65	65	80,2	46,5	23,5	40	PA14550Pv
50x32x50	50	32	50	42	65	65	87,8	47,5	23,5	40	PA14551Pv
50x40x50	50	40	50	52	65	65	94,1	51,0	23,5	32	PA14552Pv
63x25x63	63	25	63	34	82	82	87,5	50,0	27,4	24	PA14562Pv
63x32x63	63	32	63	42	82	82	96,1	55,0	27,4	24	PA14563Pv
63x50x63	63	50	63	65	82	82	112,0	56,0	27,4	16	PA14565Pv
75x25x75	75	25	75	34	100	100	99,0	57,0	31,0	12	PA14570Pv
75x32x75	75	32	75	42	100	100	102,0	57,5	31,0	12	PA14571Pv
75x40x75	75	40	75	52	100	100	108,0	60,5	31,0	10	PA14572Pv
75x50x75	75	50	75	65	100	100	120,0	66,0	31,0	10	PA14573Pv
75x63x75	75	63	75	82	100	100	139,5	69,0	31,0	8	PA14574Pv
90x50x90	90	50	90	65	110	110	147,0	75,0	35,5	4	PA14580Pv
90x63x90	90	63	90	82	110	110	146,2	76,0	35,5	4	PA14582Pv
90x75x90	90	75	90	100	110	110	146,0	78,7	35,5	4	PA14584Pv
110x63x100	110	63	110	82	147	147	180,5	85,0	37,0	2	PA14596Pv
110x75x110										2	PA14598V
110x90x110										2	PA14600V

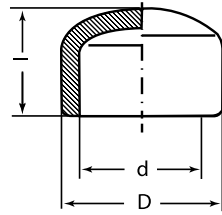

End cap

d, mm	D, mm	l, mm	Box Quantity	Code
20	29	25,5	600	PA15008Pv
25	34	29,0	400	PA15010Pv
32	42	32,5	200	PA15012Pv
40	52	38,5	150	PA15014Pv
50	65	44,0	80	PA15016Pv
63	82	52,0	48	PA15018Pv
75	100	59,0	30	PA15020Pv
90	121	60,5	18	PA15022Pv
110	147	72,0	8	PA15024v
125	-	-	-	PA15026V

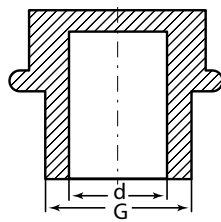

End cap male threaded

d, mm	G, inch	Box Quantity	Code
20	1/2"	PA15508P	PA15508Pv
25	3/4"	PA15510P	PA15510Pv

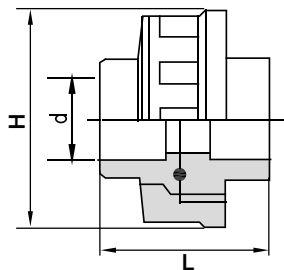

Plastic union

d, mm	L, mm	Box Quantity	Code
20	26,5	60	PA19008v
25	31,0	40	PA19010v
32	36,0	24	PA19012v
40	-	12	PA19014v
50	-	10	PA19016v
63	-	5	PA19018v
75	-	2	PA19020vv
90	-	1	PA19022vv
110	-	1	PA19024vv

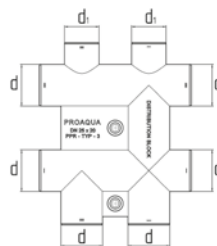

Distribution unit for water supply

d, mm	d1, mm	G, inch	Box Quantity	Code
25	20	3/4"	16	PA63012Pv

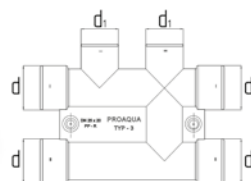

Distribution unit for heating systems

d, mm	d1, mm	L, mm	Box Quantity	Code
25	20	-	28	PA63010Pv

FITTINGS WITH BRASS INSERT

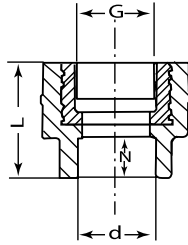

Transition piece female

d, mm	G, inch	L, mm	Z, mm	Box Quantity	Code
20	1/2"	40,5	11,0	200	PA22008Pv
20	3/4"	40,0	12,0	100	PA22010Pv
25	1/2"	40,0	9,0	150	PA22012Pv
25	3/4"	40,0	8,0	150	PA22014Pv
25	1"	-	-	60	PA22013Pv
32	1/2"	-	-	80	PA22015Pv
32	3/4"	57,0	18,0	80	PA22016Pv
32	1"	57,0	18,0	80	PA22018Pv
40	1"	-	-	80	PA22020V

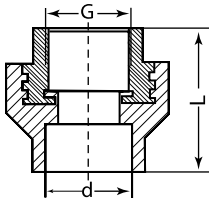

Transition piece hex. female

d, mm	G, inch	L, mm	Box Quantity	Code
32	1"	59,0	50	PA22518Pv
40	1 1/4"	63,5	20	PA22520Pv
40	1 1/2"	63,5	20	PA22521Pv
50	1 1/2"	65,5	20	PA22522Pv
50	2"	68,5	20	PA22523Pv
63	2"	77,0	12	PA22524Pv
75	2 1/2"	83,5	10	PA22526v
90	3"	104,0	8	PA22528v
110	4"	105,0	5	PA22530Pv

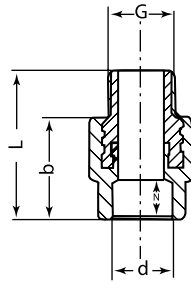

Transition piece male

d, mm	G, inch	L, mm	Z mm	b, mm	Box Quantity	Code
20	1/2"	54,5	14,5	40,0	150	PA23008Pv
20	3/4"	54,0	14,5	39,5	80	PA23010Pv
25	1/2"	54,0	16,0	38,0	150	PA23012Pv
25	3/4"	54,0	16,0	38,0	100	PA23014Pv
25	1"	-	-	-	60	PA23013Pv
32	1/2"	-	-	-	80	PA23015Pv
32	3/4"	60,0	18,0	42,0	80	PA23016Pv
32	1"	60,0	18,0	42,0	60	PA23018Pv
40	1"	-	18,0	43,0	-	PA23020V

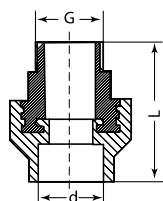

Transition piece hex. male

d, mm	G, inch	L, mm	Box Quantity	Code
32	1"	79,0	40	PA23518Pv
40	1 1/4"	84,0	20	PA23520Pv
40	1 1/2"	85,0	-	-
50	1 1/2"	85,0	16	PA23522Pv
50	2"	87	-	-
63	2"	102,0	12	PA23524Pv
75	2 1/2"	107,5	6	PA23526v
90	3"	116,0	12	PA23528v
110	4"	128,0	4	PA23530Pv

Coupling screw joint female

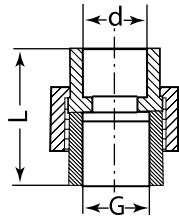

d,mm	G,inch	L,mm	Box Quantity	Code
20	1/2"	16,0	150	PA20008v
20	3/4"	-	70	PA20010v
20	1"	-	50	PA20011v
25	1/2"	-	60	PA20012v
25	3/4"	18,0	75	PA20014v
25	1"	-	50	PA20015v
32	3/4"	-	50	PA20016v
32	1"	20,0	50	PA20018v
32	1 1/4"	-	20	PA20019v
40	1 1/4"	53,0	30	PA20020v
40	1 1/2"	-	20	PA20021v
50	1 1/2"	76,0	8	PA20022v
50	2"	-	5	PA20023v
63	2"	85,0	150	PA20024v
75	2 1/2"	-	70	PA20026v

Coupling screw joint male

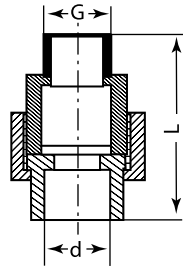

d,mm	G,inch	L,mm	Box Quantity	Code
20	1/2"	16,0	125	PA21008v
20	3/4"	-	60	PA21010v
20	1"	-	40	PA21011v
25	1/2"	-	50	PA21012v
25	3/4"	18,0	65	PA21014v
25	1"	-	40	PA21015v
32	3/4"	-	40	PA21016v
32	1"	20,0	50	PA21018v
32	1 1/4"	-	20	PA21019v
40	1 1/4"	70,0	25	PA21020v
40	1 1/2"	-	16	PA21021v
50	1 1/2"	83,0	8	PA21022v
50	2"	-	5	PA21023v
63	2"	92,0	125	PA21024v
75	2 1/2"	-	60	PA21026v

Coupling with loose nut

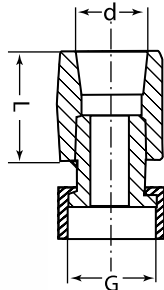

d,mm	G,inch	L,mm	z,mm	Box Quantity	Code
20	1/2"	34,0	14,5	160	PA29008v
20	3/4"	34,0	14,5	160	PA29010v
25	3/4"	39,0	16,0	100	PA29014v
25	1"	39,0	16,0	100	PA29015v
32	1"	42,0	18,0	60	PA29018v
32	1 1/4"	42,0	18,0	60	PA29019v

Reinforced coupling screw joint female

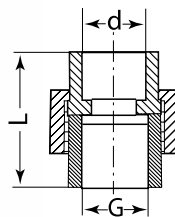

d,mm	G,inch	Box Quantity	Code
20	1/2"	150	PA20008Sv
25	3/4"	75	PA20014Sv
32	1"	50	PA20018S

Reinforced coupling screw joint male

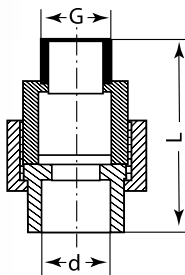

d,mm	G,inch	Box Quantity	Code
20	1/2"	150	PA21008Sv
25	3/4"	75	PA21014Sv
32	1 1/4"	50	PA21018S

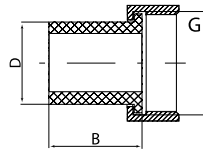

Nipple with loose nut

d, mm	G, inch	Box Quantity	Code
20	3/4"	160	PA70010v
25	1"	75	PA70014v
32	1 1/4"	160	PA70016v

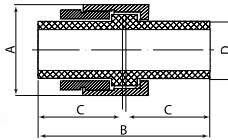

Coupling with nut

d, mm	G, inch	L, mm	Box Quantity	Code
20	3/4"	26,5	140	PA72008V
25	1"	31,0	80	PA72010V
32	1 1/4"	36,0	40	PA72012V

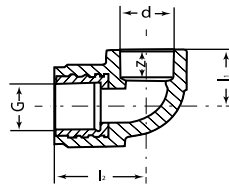

Elbow female

d, mm	G, inch	z, mm	l1, mm	l2, mm	Box Quantity	Code
20	1/2"	14,5	31,0	36,0	150	PA26008Pv
20	3/4"	14,5	30,5	42,5	120	PA26010Pv
25	1/2"	16,0	31,0	40,0	100	PA26012Pv
25	3/4"	16,0	30,5	42,5	100	PA26014Pv
32	1/2"	18,0	31,0	47,0	100	PA26015V
32	3/4"	18,0	27,5	52,0	50	PA26016Pv
32	1"	18,0	30,5	67,0	50	PA26018Pv

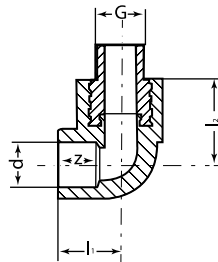

Elbow male

d, mm	G, inch	z, mm	l1, mm	l2, mm	Box Quantity	Code
20	1/2"	14,5	31,0	35,0	150	PA27008Pv
20	3/4"	14,5	31,0	35,0	100	PA27010Pv
25	1/2"	16,0	30,0	36,0	100	PA27012Pv
25	3/4"	16,0	30,5	36,0	100	PA27014Pv
32	1/2"	18	31	47	50	PA27015v
32	3/4"	18,0	27,5	43,0	40	PA27016Pv
32	1"	18,0	30,5	43,0	40	PA27018Pv

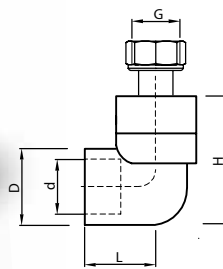

Elbow with loose nut

d, mm	G, inch	Box Quantity	Code
20	1/2"	100	PA29208v
20	3/4"	80	PA29210v
25	3/4"	100	PA29214v
25	1"	40	PA29215v
32	1"	40	PA29218v
32	1 1/4"	40	PA29219v



PEX transition piece

d, mm (PPR)	d1, mm (PEX)	Box Quantity	Code
20	16	160	PA76008Pv



Eurocone

d, mm	G, inch	Box Quantity	Code
20	3/4"	160	PA75010Pv



Wall mount elbow female

d, MM	G, inch	D, MM	D1, MM	L, MM	L1, MM	h, MM	Z, MM	Z1, MM	Box Quantity	Code
20	1/2"	35	29	35	27	15	21	11	150	PA28008Pv
25	1/2"	35	34	37	30	17	23	14	100	PA28012Pv
25	3/4"	-	-	-	-	-	-	-	100	PA28114Pv

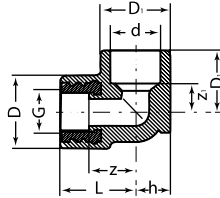

Wall mount elbow male

d, MM	G, inch	D, MM	D1, MM	L, MM	L1, MM	h, MM	Z, MM	Z1, MM	Box Quantity	Code
20	1/2"	35	29	35	27	15	21	11	120	PA28108Pv
25	1/2"	35	34	37	30	17	23	14	100	PA28112Pv
25	3/4"	-	-	-	-	-	-	-	90	PA28014Pv



Bypass elbow 90° female

d, MM	G, inch	L, MM	Z, MM	Box Quantity	Code
20	1/2"			50	PA13912v

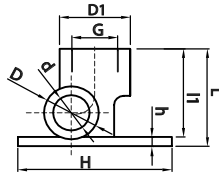

Bypass elbow 90° male

d, MM	G, inch	L, MM	Z, MM	Box Quantity	Code
20	1/2"			50	PA13812v

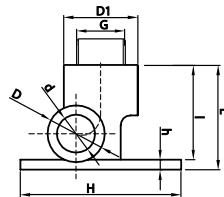

Transition T-piece female

d, MM	G, inch	D, MM	I, MM	I1, MM	Z, MM	Z1, MM	Box Quantity	Code
20	1/2"	29	31,0	36,0	16,5	20,5	150	PA24008Pv
20	3/4"	29	31,0	40,0	16,5	29,0	100	PA24010Pv
25	1/2"	34	31,0	40,0	15,0	24,5	100	PA24012Pv
25	3/4"	34	33,0	44,5	15,0	31,0	80	PA24014Pv
32	1/2"	-	-	-	-	-	60	PA24015v
32	3/4"	42	27,5	52,0	9,5	36,5	50	PA24016Pv
32	1"	42	30,5	67,5	12,5	34,0	50	PA24018Pv

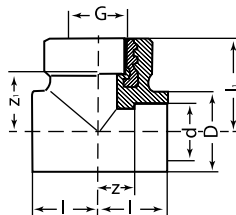

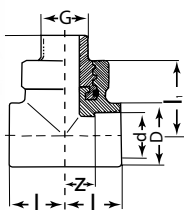

Transition T-piece male

d, mm	G, inch	D, mm	l, j, mm	l1, mm	Z, mm	Z1, mm	Box Quantity	Code
20	1/2"	29	31,0	34,0	16,5	50,0	100	PA25008Pv
20	3/4"	29	28,0	35,0	14,0	50,0	80	PA25010Pv
25	1/2"	34	32,0	38,0	16,0	53,0	100	PA25012Pv
25	3/4"	34	32,0	40,0	16,0	55,0	50	PA25014Pv
32	1/2"	-	-	-	-	-	50	PA25015v
32	3/4"	-	-	-	-	-	60	PA25016Pv
32	1"	42	38,0	48,0	20,0	66,0	40	PA25018Pv

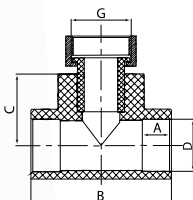

T-Piece with loose nut

d, mm	G, inch	L, mm	Box Quantity	Code
20	1/2"	62,0	120	PA29108v
20	3/4"	62,0	90	PA29110v
25	3/4"	68	60	PA29114v
25	1"	66,0	40	PA29115v
32	1"	68	40	PA29118v
32	1 1/4"	68,0	30	PA29119v

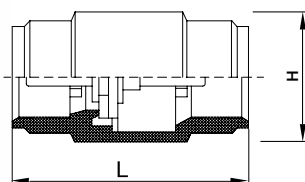

Check valve

d, mm	Box Quantity	Code
20	100	PA47008v
25	80	PA47010v
32	50	PA47012v

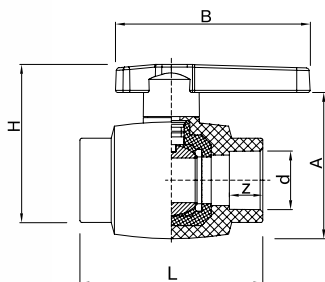

Ball Valve Standard

d, mm	Box Quantity	Code
20	60	PA44008v
25	50	PA44010v
32	30	PA44012v
40	20	PA44014v

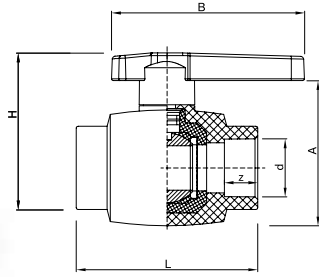

Ball valve Prime

d,mm	Box Quantity	Code
20	60	PA40508v
25	50	PA40510v
32	30	PA40512v

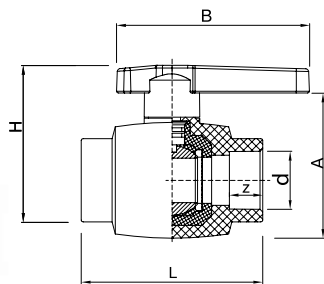

Ball valve Ultra

d,mm	Box Quantity	Code
20	50	PA40008v
25	40	PA40010v
32	25	PA40012v
40	25	PA40014v
50	10	PA40016v
63	6	PA40018v
75		PA40020v

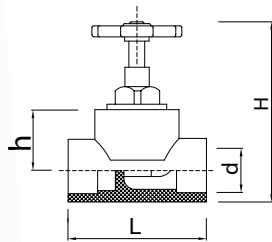

Globe valve

d,mm	L,mm	h,mm	Box Quantity	Code
20	77	27,5	50	PA42009v
25	77	27,5	40	PA42011v
32	106	36,0	20	PA42013v

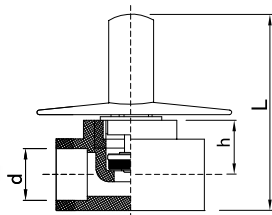

Chromium valve

d,mm	L,mm	h,mm	Box Quantity	Code
20	77	27,5	25	PA43008v
25	77	27,5	20	PA43010v
32	122	34	32	PA43012v



Radiator ball valve straight

d, mm	G, inch	Box Quantity	Code
20	1/2"	60	PA41008v
25	3/4"	60	PA41010v

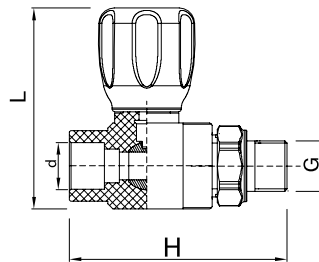

Radiator ball valve elbow

d, mm	G, inch	Box Quantity	Code
20	1/2"	50	PA42108v
25	3/4"	50	PA42110v

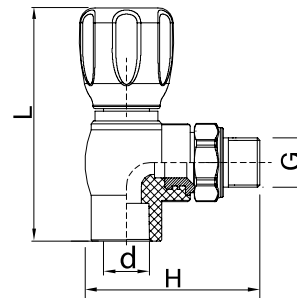

Double elbow with holder female

d, mm	G, inch	Box Quantity	Code
20	1/2"	150	PA280008Pv
25	1/2"	60	PA280012Pv

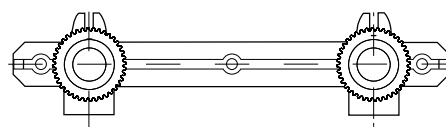

Double elbow with holder male

d, mm	G, inch	Box Quantity	Code
20	1/2"	120	PA280108Pv
25	1/2"	100	PA280112Pv

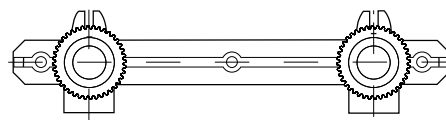



Filter F/F

D, mm	Box Quantity	Code
20	80	PA440008v
25	50	PA440010v
32	30	PA440012v
40	20	PA440014v

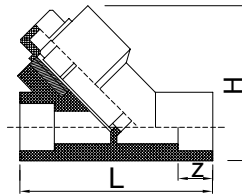

Filter F/M

D, mm	Box Quantity	Code
20	80	PA450008v
25	50	PA450010v
32	30	PA450012v
40	20	PA450014v

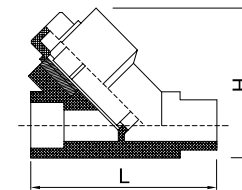

Mounting group

d, mm	G, inch	Box Quantity	Code
20	1/2"	20	PA60008v
25	1/2"	16	PA60010v

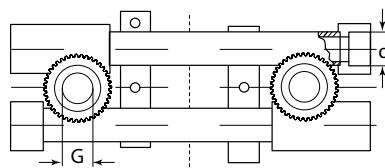

Assembling plate

Size, L	Box Quantity	Code
200	90	PA91100v

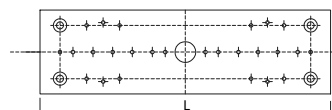

TOOLS



Complete welding set – 1500W

Power, Watt	Code
1500	CM-01

The Set Includes:

1. Metal Box,
2. Welding Machine,
3. Welding Adaptors (D 20, 25, 32)
4. Pipe Cutter,
5. Stand



Complete welding set – 1500W

Power, Watt	Code
1500	RM-02

The Set Includes:

- Metal case;
- Welding Machine;
- Welding Adaptors (20, 25, 32, 40 mm);
- Stand



Complete welding set – 2000W

Power, Watt	Code
2000	RM-04

he Set Includes:

- Metal case;
- Welding Machine;
- Welding Adaptors (50, 63,75, 90, 110 mm);
- Stand

Welding adaptors

D, mm	Box Quantity	Code
20	1	PA51008
25	1	PA51010
32	1	PA51012
40	1	PA51014
50	1	PA51016
63	1	PA51018
75	1	PA51020
90	1	PA51022
110	1	PA51024
125	1	PA53026





Pipe cutter

Size	Box Quantity	Code
16-42	48	ANT-PC-301



Pipe cutter

Size	Box Quantity	Code
50-75	10	PPC-75



Shaver for blanche/grise pipe

D, mm	Box Quantity	Code
16-20	1	PA52006
20-25	1	PA52008
32-40	1	PA52010
50-63	1	PA52012
75	1	PA52014
90	1	PA52016
110	1	PA52018



Shaver for DUO pipe

D, mm	Box Quantity	Code
20-25	1	PA527008
32-40	1	PA527010
50-63	1	PA527012
75	1	PA527014



Shaver for perforating tool

D, mm	Box Quantity	Code
16	1	PA52506
20	1	PA52507
25	1	PA52508
32	1	PA52509
40	1	PA52510
50	1	PA52511
63	1	PA52512
110	1	PA52518

EXAMPLE OF DISTRIBUTION BLOCKS ARRANGEMENT FOR WATER SUPPLY AND HEATING SYSTEMS

Distribution block is used in water supply systems. The applied numbers I and II indicate the belonging of the junction points of distribution blocks. They are designed to facilitate installation. The presence of additional taps in the distribution block makes it possible to connect a larger number of pipelines, for example, a circulation pipe. Hot water is supplied through the system of internal pipelines to the taps along with cold water. Despite the obligatory heat insulation of pipes with hot water, the water in the pipes has time to cool down for 8-10 hours while you are not using it. If the distance from the boiler to the faucet is large (for example, the upper floor), it is necessary to drain the water from the faucet for 3-5 minutes until it becomes warm. If you constantly drain the water, there is no desire, then you need to choose a system with recirculation of hot water. For this purpose, the best fit distribution block for water supply.

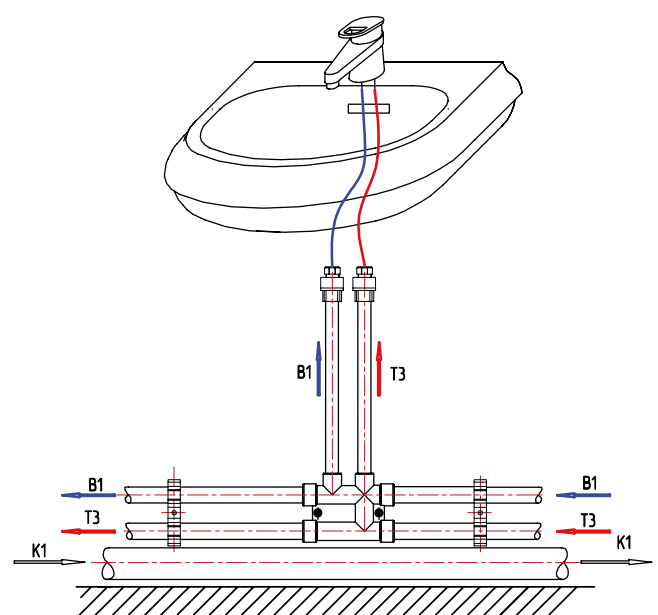
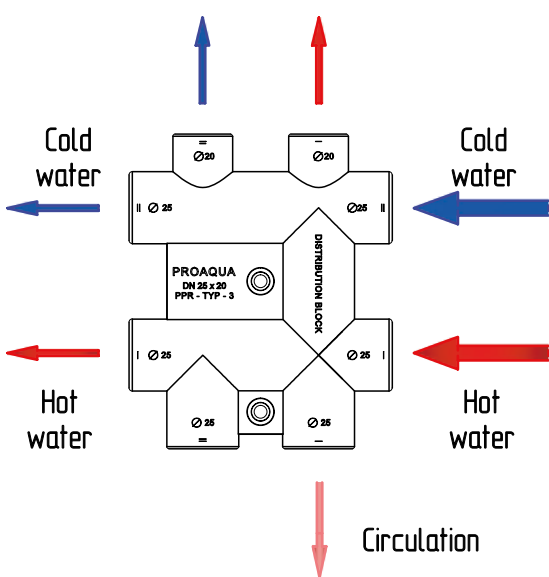
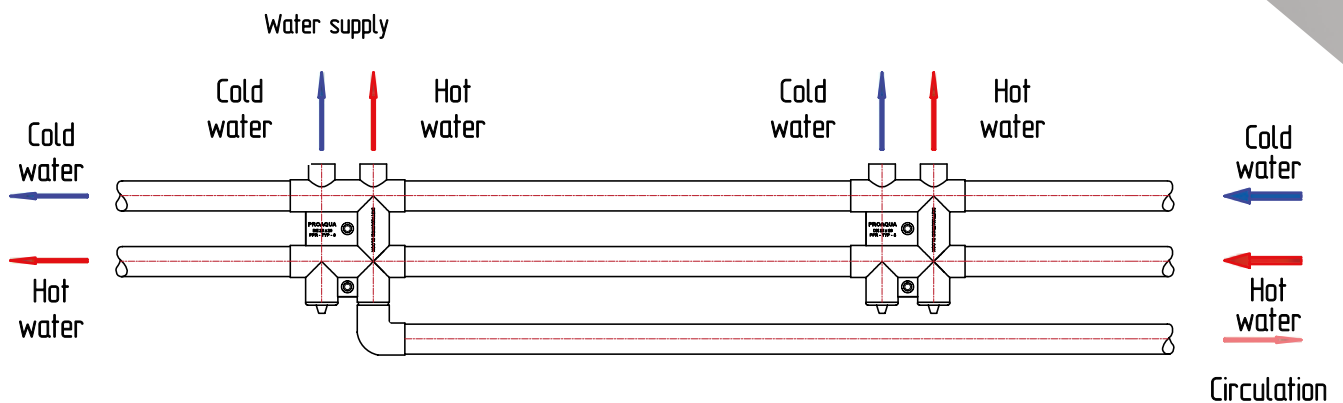

WATER SUPPLY

WASHBASIN

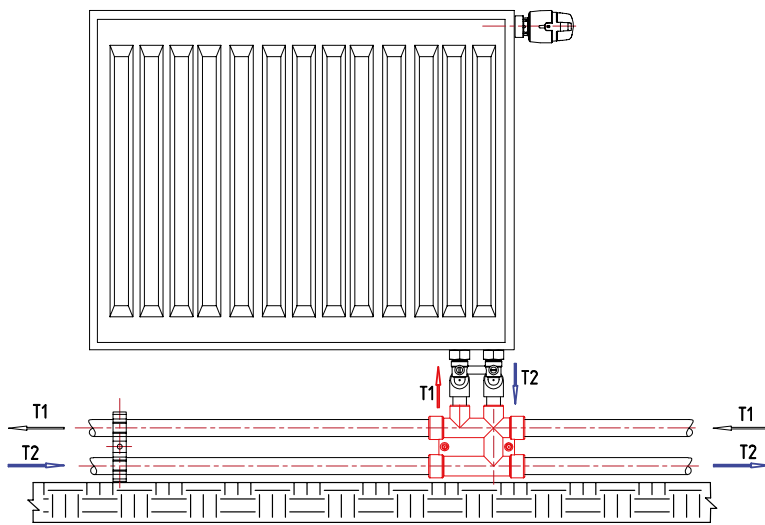

PANEL RADIATOR

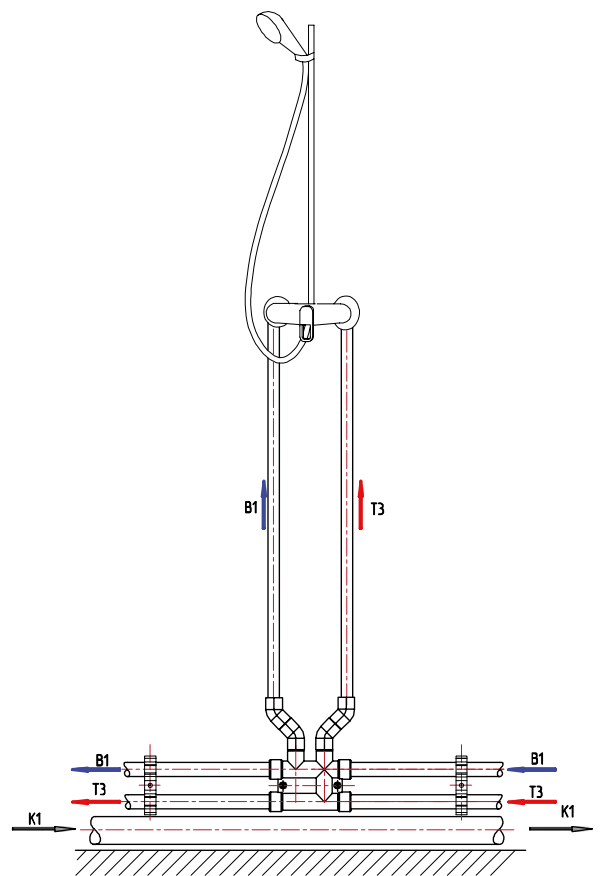

SHOWER



**The best equipment
allows us to produce
the best products**



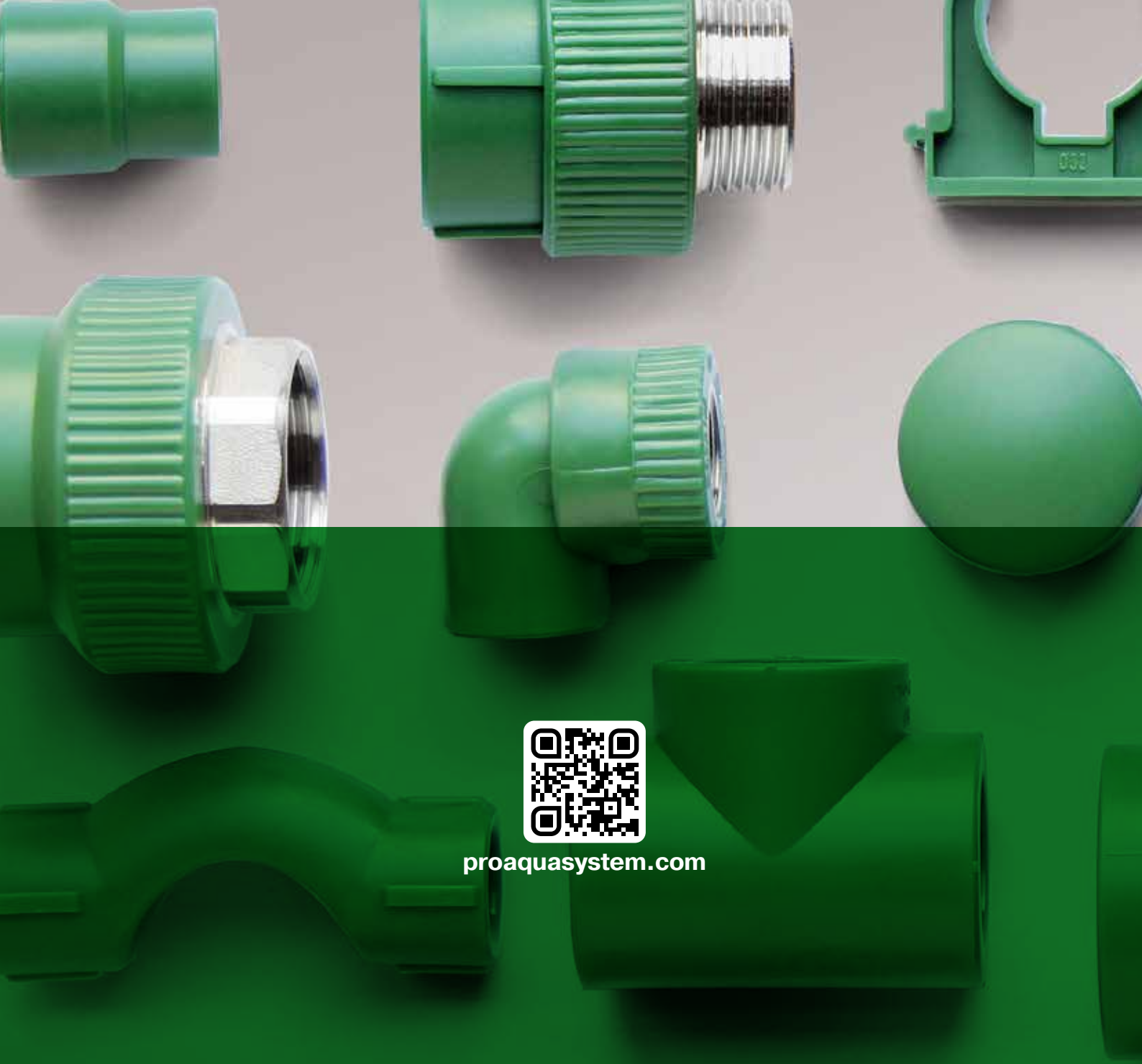

proaquasystem.com

